

ENGLISH



Canon

Canon DIGITAL CAMERA *PowerShot S60* Camera User Guide

Canon
PowerShot S60
DIGITAL CAMERA
Camera User Guide

DiG!C



- Please read the *Read This First* section (p. 4).
- Please also see the *Software Starter Guide* and the *Direct Print User Guide*.

Disclaimer

- While every effort has been made to ensure that the information contained in this guide is accurate and complete, no liability can be accepted for any errors or omissions.
- Canon reserves the right to change the specifications of the hardware and software described herein at any time without prior notice.
- No part of this guide may be reproduced, transmitted, transcribed, stored in a retrieval system, or translated into any language in any form, by any means, without the prior written permission of Canon.
- Canon makes no warranties for damages resulting from corrupted or lost data due to a mistaken operation or malfunction of the camera, the software, the CompactFlash™ cards (CF cards), personal computers, peripheral devices, or use of non-Canon CF cards.

Trademark Acknowledgements

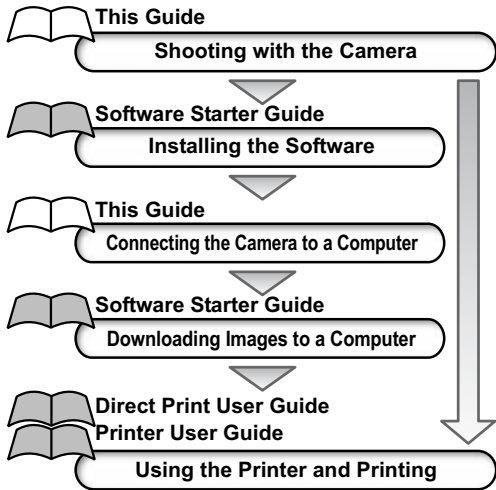
- Canon and PowerShot are trademarks of Canon Inc.
- CompactFlash is a trademark of SanDisk Corporation.
- iBook and iMac are trademarks of Apple Computer, Inc.
- Macintosh, PowerBook, Power Macintosh and QuickTime are trademarks of Apple Computer, Inc., registered in the United States and other countries.
- Microsoft, Windows, and Windows NT are either registered trademarks or trademarks of Microsoft Corporation in the United States and/or other countries.
- Other names and products not mentioned above may be registered trademarks or trademarks of their respective companies.

Use of genuine Canon accessories is recommended.







This product is designed to perform optimally when used with genuine Canon accessories. Canon shall not be liable for any damage to this product and/or accidents such as fire, etc., caused by the malfunction of non-genuine Canon accessories (e.g., a leakage and/or explosion of a battery pack). Please note that this warranty does not apply to repairs arising out of the malfunction of non-genuine Canon accessories, although you may request such repairs on a chargeable basis.

About this Camera User Guide

Flowchart and Reference Guides



Symbols Used

Icons under title bars show the operations mode. As in the example below, the mode dial should be set to **AUTO**, , , , , , , **P**, **Tv**, **Av**, or **M**.

Using the Flash

Shooting Mode Dial

AUTO       **P Tv Av M**



This mark denotes issues that may affect the camera's operation.



This mark denotes additional topics that complement the basic operating procedures.

Table of Contents

Items marked with ★ are lists or charts that summarize camera functions or procedures.

Read This First

Chapter 1. Preparing the Camera

Components Guide	10
Controls	12
Installing the Battery Pack/CF Card	14
Turning the Power On/Off	21
Setting the Date/Time	24
Setting the Language	26
★ Using the LCD Monitor	27

Chapter 2. Shooting-The Basics

★ AUTO Auto Mode	30
Reviewing an Image Right after Shooting	33
Changing the Resolution and Compression	35
⚡ Using the Flash	38

Chapter 3. Playback-The Basics

Displaying Images Individually	42
🔍 Magnifying Images	43
Viewing Images in Sets of Nine (Index Playback)	44
JUMP Jumping Between Images	45

Chapter 4. Erasing



🗑 Erasing Images Individually	46
Erasing All Images	47

Chapter 5. Useful Shooting Functions


Using the Shooting Mode Dial (Image Zone)	48
👤 Portrait	
🌄 Landscape	
🌃 Night Scene	
📷 Fast Shutter	
📷 Slow Shutter	
📷 Shooting Panoramic Images (Stitch Assist)	50
🔍 Macro Mode	52
⌚ Using the Self-timer	53
Digital Zoom	54
📷 Continuous Shooting	56
Changing the File Format	57
🎬 Movie Mode	58
Viewing/Editing Movies	60

Chapter 6. Shooting-Advanced Functions

★ Selecting Menus and Settings	63
Resetting the Settings to Default	71
Using the Mode Dial (Creative Zone)	72
P Program AE	
Tv Setting the Shutter Speed	
Av Setting the Aperture	
M Manually Setting the Shutter	

 Selecting an AF Frame	76
 Switching between Light Metering Modes	78
Adjusting the Exposure	80
Adjusting the Tone (White Balance)	81
Changing the ISO Speed.	84
Changing the Photo Effect.	85
Auto Exposure Bracketing (AEB Mode)	86
Focus Bracketing (Focus-BKT Mode)	87
Locking the Exposure Setting (AE Lock)	89
Locking the Flash Exposure Setting (FE Lock)	90
Switching between Flash Adjustment Settings	91
Switching the Timing at which the Flash Fires	93
Shooting Images at Set Intervals (Intervalometer)	94
Shooting Problem Subjects for the Autofocus	96
C Saving Custom Settings	100

Chapter 7. Playback-Advanced Functions

Rotating Images in the Display	102
 Attaching Sound Memos to Images.	103
Automated Playback (Slide Show)	104
Protecting Images	108

Chapter 8. Camera Settings

Setting the Power Saving Function	109
Setting the Auto Rotate Function.	111
Resetting the File Numbers.	112
Customizing the Camera (My Camera Settings).	113

Chapter 9. Additional Features

Downloading Images to a Computer	117
Computer System Requirements	117
Viewing Images on a TV Set	124
About Printing	126
Print Settings (DPOF Print Settings)	128
Image Transmission Settings (DPOF Transfer Order)	133

Appendix

List of Messages	136
Troubleshooting.	138
Using the Wireless Controller (Sold Separately).	143
Using Conversion Lenses (Sold Separately).	145
Using the Power Kits (Sold Separately)	147
Using a Car Battery Charger (Sold Separately)	149
Camera Care and Maintenance	150
Specifications	151
Photo Tips and Information	159
Index	162
★ Functions Available in Each Shooting Mode.	170

Read This First

Please Read

Test Shots

Before you try to photograph important subjects, we highly recommend that you shoot several trial images to confirm that the camera is operating and being operated correctly. Please note that Canon Inc., its subsidiaries and affiliates, and its distributors are not liable for any consequential damages arising from any malfunction of a camera or accessory, including CompactFlash™ cards, that results in the failure of an image to be recorded or to be recorded in a format that is machine readable.

Warning Against Copyright Infringement

Please note that Canon digital cameras are intended for personal use and should never be used in a manner that infringes upon or contravenes international or domestic copyright laws and regulations. Please be advised that in certain cases the copying of images from performances, exhibitions, or commercial properties by means of a camera or other device may contravene copyright or other legal rights even if the image was shot for personal use.

Warranty Limitations

This camera's warranty is only effective in the country of sale. If a problem arises while the camera is in use abroad, please convey it back to the country of sale before proceeding with a warranty claim to a Canon Customer Support Help Desk.

For Canon Customer Support contacts, please see the Canon Limited Warranty supplied with your camera.

Camera Body Temperature

If your camera is used for prolonged periods, the camera body may become warm. Please be aware of this and take care when operating the camera for an extended period.

About the LCD Monitor

The LCD monitor is produced with extremely high-precision manufacturing techniques. More than 99.99% of the pixels operate to specification. Less than 0.01% of the pixels may occasionally misfire or appear as red or black dots. This has no effect on the recorded image and does not constitute a malfunction.

Video Format

Please set the camera's video signal format to the one used in your region before using it with a TV monitor (p. 69).

Language Setting

Please see page 26 to change the language setting.

Please read through the "Read This First" section (p. 4) before using your camera.

Safety Precautions

- Before using the camera, please ensure that you read and understand the safety precautions described below. Always ensure that the camera is operated correctly.
- The safety precautions noted on the following pages are intended to instruct you in the safe and correct operation of the camera and its accessories to prevent injuries or damage to yourself, other persons and equipment.
- In the next few pages, the term "equipment" refers primarily to the camera, its battery, separately sold battery charger and separately sold compact power adapter.



Warnings

-
- **Do not aim the camera directly into the sun or at other intense light sources** which could damage your eyesight.
 - **Do not trigger the flash in close proximity to human or animal eyes.** Exposure to the intense light produced by the flash may damage eyesight. In particular, remain at least one meter (39 inches) away from infants when using the flash.
 - **Store this equipment out of the reach of children and infants.** Accidental damage to the camera or battery by a child could result in serious injury. In addition, placement of the strap around a child's neck could result in asphyxiation.
 - **Do not attempt to disassemble or alter any part of the equipment that is not expressly described in this guide.** Disassembly or alteration may result in high-voltage electrical shock. Internal inspections, alterations and repairs should be conducted by qualified service personnel authorized by your camera distributor or a Canon Customer Support Help Desk.
 - **To avoid the risk of high-voltage electrical shock, do not touch the flash portion of the camera if it has been damaged.** Similarly, never touch internal portions of the equipment that become exposed as a result of damage. There is a risk of high-voltage electrical shock. Please take the first opportunity to consult your camera distributor or a Canon Customer Support Help Desk.
-

-
- **Stop operating the equipment immediately if it emits smoke or noxious fumes.** Failure to do so may result in fire or electrical shock. Immediately turn the camera's power off, remove the battery and unplug the power cord from the power outlet. Confirm that smoke or fume emissions have ceased. Please consult your camera distributor or the closest Canon Customer Support Help Desk.
 - **Stop operating the equipment immediately if it is dropped or the casing is damaged.** Failure to do so may result in fire or electrical shock. Immediately turn the camera's power off, remove the battery or unplug the power cord from the power outlet. Please consult your camera distributor or the closest Canon Customer Support Help Desk.
 - **Do not allow the equipment to come into contact with, or become immersed in, water or other liquids.** Do not allow liquids to enter the interior. The camera has not been waterproofed. If the exterior comes into contact with liquids or salt air, wipe it dry with a soft, absorbent cloth. In the event that water or other foreign substances enter the interior, immediately turn the camera's power off and remove the battery or unplug the power cord from the power outlet. Continued use of the equipment may result in fire or electrical shock. Please consult your camera distributor or the closest Canon Customer Support Help Desk.
 - **Do not use substances containing alcohol, benzene, thinners or other flammable substances to clean or maintain the equipment.** The use of these substances may lead to fire.
-

● **Remove the power cord on a regular periodic basis and wipe away the dust and dirt that collects on the plug, the exterior of the power outlet and the surrounding area.** In dusty, humid or greasy environments, the dust that collects around the plug over long periods of time may become saturated with humidity and short-circuit, leading to fire.

● **Do not cut, damage, alter or place heavy items on the power cord.** Any of these actions may cause an electrical short circuit, which may lead to fire or electrical shock.

● **Do not handle the power cord if your hands are wet.** Handling it with wet hands may lead to electrical shock. When unplugging the cord, ensure that you hold the solid portion of the plug. Pulling on the flexible portion of the cord may damage or expose the wire and insulation, creating the potential for fires or electrical shocks.

● **Use only the recommended power accessories.** Use of power sources not expressly recommended for this equipment may lead to overheating, distortion of the equipment, fire, electrical shock or other hazards.

● **Do not place the Battery near a heat source or expose them to direct flame or heat.** Neither should you immerse them in water. Such exposure may damage the Battery and lead to the leakage of corrosive liquids, fire, electrical shock, explosion or serious injury.

● **Do not attempt to disassemble, alter or apply heat to the Battery.** There is serious risk of injury due to an explosion. Immediately flush with water any area of the body, including the eyes and mouth, or clothing that comes into contact with the inner contents of a battery. If the eyes or mouth contact these substances, immediately flush with water and seek medical assistance.

● **Avoid dropping or subjecting the Battery to severe impacts that could damage the casings.** It could lead to leakage and injury.

● **Do not short-circuit the battery terminals with metallic objects, such as key holders.** It could lead to overheating, burns and other injuries.

● **Before you discard a battery, cover the terminals with tape or other insulators to prevent direct contact with other objects.** Contact with the metallic components of other materials in waste containers may lead to fire or explosion. Discard the Battery in specialized waste facilities if available in your area.

● **Please use the designated battery pack and battery charger.** Use of another charger may cause the battery to rupture or leak, posing a risk of fire, injury, and damage to the surroundings.

● **Disconnect the battery charger or the compact power adapter from both the camera and power outlet after recharging and when the camera is not in use** to avoid fires and other hazards.

● **The camera terminal of the separately sold compact power adapter is designed for exclusive use with your camera.** Do not use it with other products or battery. There is a risk of fire and other hazards.

● **Exercise due caution when screwing on the separately sold wide converter, tele-converter and conversion lens adapter.** If they loosen, fall off and shatter, the glass shards may cause an injury.

Caution about magnetic fields

Keep objects that are sensitive to magnetic fields (such as credit cards) away from the speaker of the camera (p. 12). Such items may lose data or stop working.



CAUTIONS

- **Avoid using, placing or storing the equipment in places subject to strong sunlight or high temperatures, such as the dashboard or trunk (boot) of a car.** Exposure to intense sunlight and heat may cause the battery to leak, overheat or explode, resulting in fire, burns or other injuries. High temperatures may also cause deformation of the casing. Ensure that there is good ventilation when using the battery charger to charge the battery.
- **Do not store the equipment in humid or dusty areas.** Storage in such areas could lead to fire, electrical shock or other damage.
- **Be careful not to bang the camera or subject it to strong impacts or shocks that could lead to injury or damage the equipment when wearing or holding it by the strap.**
- **Be careful not to cover the flash with your fingers or clothing when shooting.** The flash may be damaged and emit smoke or noise. In addition, do not touch the surface of the flash after taking several pictures in rapid succession. Either action could result in burns.
- **Do not operate the flash with dirt, dust or other items stuck to its lens.** The resulting heat build-up could damage the flash.
- **Ensure that the battery charger or compact power adapter is plugged into a power outlet of the specified rating, not over the specified rating.** The plug of the battery charger or compact power adapter varies according to region.
- **Do not use the battery charger or compact power adapter if the power cord is damaged or if the plug is not fully inserted into the power outlet.**

- **Do not allow metal objects (such as pins or keys) or dirt to contact the charger terminals or plug.**
- **If your camera is used for prolonged periods, the camera body may become warm.** Please take care when operating the camera for an extended period as your hands may experience a burning sensation.

Preventing Malfunctions

Avoid Strong Magnetic Fields

Never place the camera in close proximity to electric motors or other equipment generating strong electromagnetic fields. Exposure to strong magnetic fields may cause malfunctions or corrupt image data.

Avoid Condensation Related Problems

Moving the equipment rapidly between hot and cold temperatures may cause condensation (water droplets) to form on its external and internal surfaces. You can avoid this by placing the equipment in an airtight, resealable plastic bag and letting it adjust to temperature changes slowly before removing it from the bag.

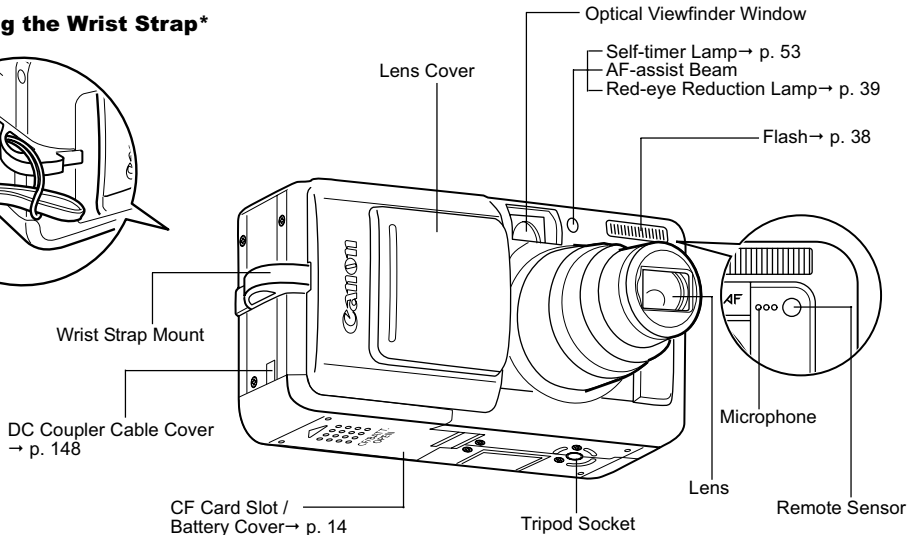
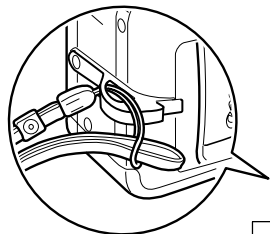
If Condensation Forms Inside the Camera

Stop using the camera immediately if you detect condensation. Continued use may damage the equipment. Remove the CF card, battery or compact power adapter from the camera and wait until the moisture evaporates completely before resuming use.

Extended Storage

When not using the camera for extended periods of time, remove the battery from the camera or battery charger and store the equipment in a safe place. Storing the camera for extended periods with the battery installed will run down the battery. The date, time and other camera settings may reset to default settings if the battery pack has been removed for more than three weeks.

Attaching the Wrist Strap*



* Avoid waving the camera about or catching it on other items when suspending it from the strap.


The following cables are used to connect the camera to a computer or printer.

● **Computer:** Interface Cable IFC-400PCU (supplied with the camera)

● **Direct Print Compatible Printers (Sold Separately):**

- CP Printers: Interface Cable IFC-400PCU (supplied with the camera) or the Direct Interface Cable DIF-100 (supplied with the printer).
- Bubble Jet Printers
 - *Bubble Jet Direct* Compatible Printers: Please refer to your Bubble Jet printer user guide.
 - *PictBridge* Compliant Printers: Interface Cable IFC-400PCU (supplied with the camera)
- *PictBridge* Compliant Non-Canon Printers: Interface Cable IFC-400PCU (supplied with the camera)

Please refer to the *System Map* or the *Direct Print User Guide* supplied with the camera for direct print compatible printer information.

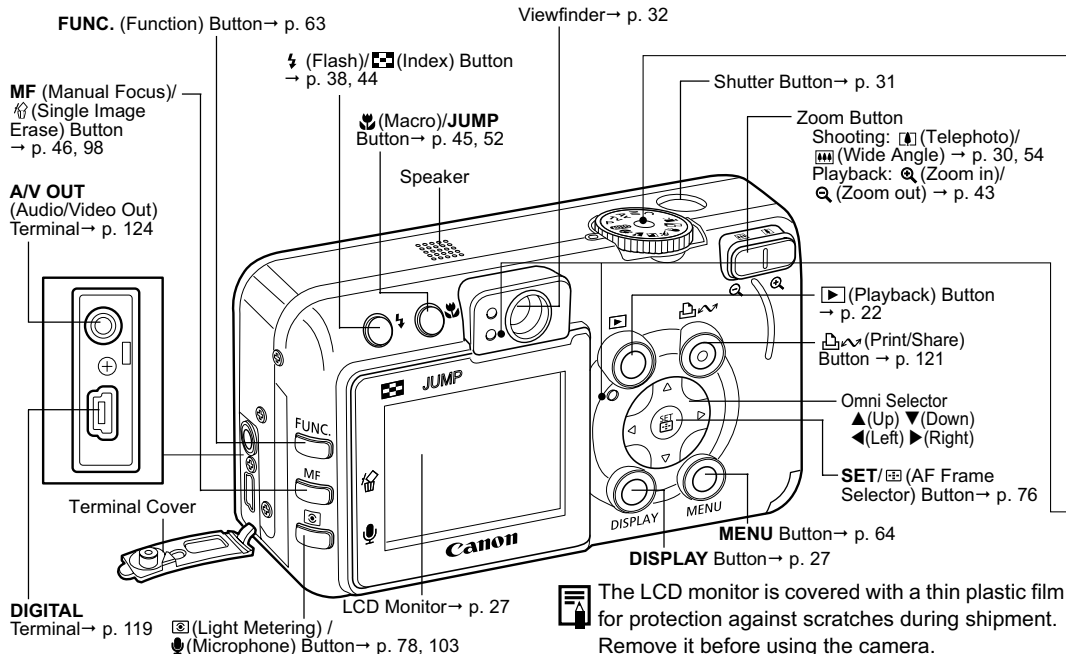
The following operations are accessible through one easy press of the  (Print/Share) button (p. 12).

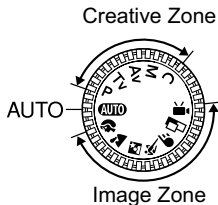
- Printing: See the *Direct Print User Guide* (separate from this guide)
- Downloading images (Windows only): See p. 117 of this guide and the *Software Starter Guide* (separate from this guide)

The indicator blinks or lights during a printer or computer connection.

- Blue: Ready to print / Ready to transfer images
- Blinking blue: Printing / Transferring

Controls





Shooting Mode Dial

Use the mode dial to switch between the Shooting modes.

- **AUTO** : Auto → p. 30

The camera automatically selects settings.

- **Image Zone** → p. 48

The camera automatically selects settings according to the image composition type.

- : Portrait
- : Landscape
- : Night Scene

- : Fast Shutter
- : Slow Shutter
- : Stitch Assist → p. 50
- : Movie → p. 58

- **Creative Zone** → p. 72

The user selects exposure, aperture or other settings to achieve special effects.

- **P** : Program AE
- **Tv** : Shutter Speed-priority AE
- **Av** : Aperture-priority AE
- **M** : Manual Exposure
- **C** : Custom

The indicator lights or blinks when the shutter button is pressed or the following operations are underway.

● Power/Mode Indicator

- Orange: Shooting mode
- Green: Playback mode/Printer connection
- Yellow: Computer connection

● Upper Indicator

- Green: Ready to record
- Blinking Green: Recording to CF card / Reading CF card / Erasing from CF card / Transmitting data (during a computer connection)

- Orange: Ready to record (flash on)
- Blinking Orange: Ready to record (camera shake warning)

● Lower Indicator

- Yellow: Macro mode / Manual focus mode
- Blinking Yellow: Focusing difficulty (although you can press the shutter button, try adjusting the focus manually, p. 96)

Installing the Battery Pack/CF Card

Install the supplied Battery Pack NB-2LH and CF card in the camera to get ready for shooting.

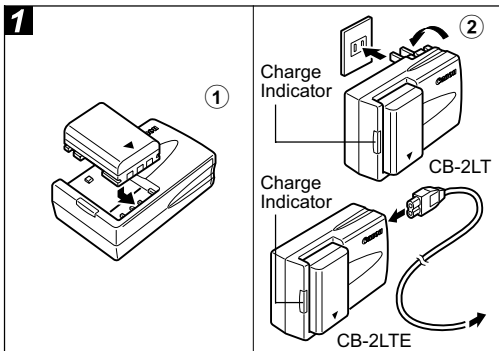
When your camera is first used or the "Change the battery pack" message is displayed, charge the battery pack.



- When the upper indicator blinks green, the camera is writing, reading, erasing or transmitting an image to or from the card. Do not perform the following or image data may be lost or corrupted:
 - Do not shake the camera.
 - Do not turn off the power or open the CF card slot / battery cover.
- To protect the battery pack and prevent a deterioration of its performance, do not continuously charge it for more than 24 hours.



- ◆ The use of the separately sold AC Adapter Kit ACK700 is recommended to power the camera during long usage sessions.
- ◆ See *Battery Performance* (p. 155).
- ◆ The Battery Pack NB-2L may also be used.



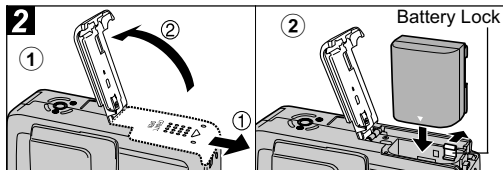
- ① **Align the edge of the battery pack with the line on the battery charger, then slide the battery in the direction of the arrow.**
- ② **(For CB-2LT)* Plug the battery charger into a power outlet.**
(For CB-2LTE)* Attach the power cord to the

battery charger and plug it into a power outlet.

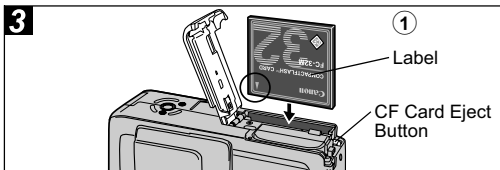
* Battery charger model names and types vary by region.

(For CB-2LT and CB-2LTE)

- The charge indicator will light red while the battery pack is charging. It will change to a steady green when the charge is complete.
- After charging, unplug the battery charger and remove the battery pack from it.



- ① **Be sure that the camera power is off (p. 21). Slide the CF card slot / battery cover in the direction of the arrow and open the cover.**
- ② **Hold back the battery lock in the direction of the arrow with the corner of the battery pack, then insert the battery pack into the compartment until it is locked.**
 - To remove the battery pack, release the battery lock.



① Insert the CF card with its label facing towards you and close the CF card slot / battery cover.

- Push the card in until the CF card eject button fully extends. To remove the CF card, push the CF card eject button and pull the card out.



- Please note that CF cards formatted with other manufacturers' cameras or a computer, or formatted or edited with application programs, may slow down writing to the CF card or prevent the card from operating correctly in the camera.
- See *CF Cards and Estimated Capacities (Recordable Images)* (p. 156).
- You are recommended to use CF cards that have been formatted in your camera (p. 19). The card supplied with the camera may be used without further formatting.

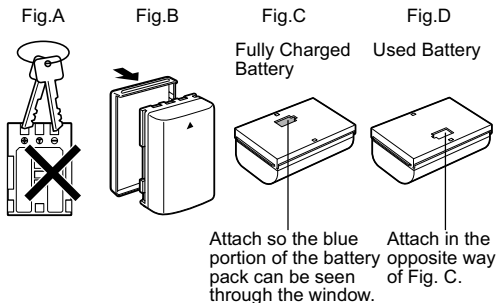


- ◆ This is a lithium ion battery pack so there is no need to completely use or discharge it before recharging. It can be recharged at any time.
- ◆ It takes approximately 90 minutes to bring a fully discharged battery pack to full charge (based on Canon's testing standard). Charging it within a temperature range of 5 to 40 °C (41 to 104 °F) is recommended.
- ◆ You may hear a noise during charging. This is not a malfunction.

Battery Pack Handling Precautions

- Keep the battery pack and camera terminals (⊕⊖) clean at all times. Dirty terminals may cause a poor contact between the battery pack and camera. Polish the terminals with a tissue or a dry cloth before charging or using the battery pack.
- Do not cover the battery charger with anything, such as a tablecloth, cushion or blanket, when it is charging. Heat will build up internally and possibly lead to fire.
- Do not charge Battery other than Battery Pack NB-2LH/NB-2L (sold separately) with the supplied battery charger.
- The battery pack continues to discharge a small amount when left in the camera (even with the power turned off) or battery charger. This shortens the battery life. Remove the battery pack when the camera is not in use.
- Do not allow any metal objects such as keyrings to touch the "+" and "-" terminals (Fig. A), as this can damage the battery pack. To carry the battery pack, or store it during periods of disuse, always replace the terminal cover (Fig. B). When using Battery Pack NB-2LH, you can distinguish between a discharged battery pack and fully charged battery pack by changing the direction of the battery cover

(Fig. C and D). Recharge the battery fully before using it again.




- Even charged battery packs continue to discharge naturally. You are advised to charge the battery on the day of use, or one day before, to ensure a full charge.
- Since storing a fully charged battery pack for long periods of time (about 1 year) can shorten its lifecycle or affect performance, you are recommended to use the battery pack in the camera until it is completely discharged and to store it at normal temperature (23 °C/ 73 °F) or lower. If you do not use the battery pack for long

periods of time, charge it fully and discharge it fully in the camera at least once a year before returning it to storage.

- The camera consumes the battery charge when the power is on even when a function is not being used. To conserve the battery charge, be particularly attentive in turning the camera off.
- Although the battery pack's maximum operating range is 0 to 40 °C (32 to 104 °F), the optimal range is 10 to 30 °C (50 to 86 °F). At cold temperatures, such as those experienced when skiing, performance will temporarily decline, reducing the usable time before recharging.
- If the usable time of a battery pack diminishes substantially even when fully charged, it should be replaced.

Battery Status Indications

The following icons or messages indicate the battery status on the LCD monitor.

	Battery pack charge is low. Recharge it as soon as possible before it is required for an extended period.
Change the battery pack	Battery charge is insufficient to operate the camera. Replace the battery pack immediately.



See *Battery Performance* (p. 155).

CF Card Handling Precautions


- CF cards are high-precision electronic devices. Do not bend, force, or subject them to shocks or vibration.
- Do not attempt to disassemble or alter a CF card.
- Moving a CF card rapidly between temperature extremes may cause condensation to form in the card, leading to potential malfunctions. To avoid condensation formation, place the CF card in a sealed plastic bag before moving it into a different temperature zone and allow it to adjust slowly to the new temperature. If condensation forms on the CF card, put it aside until the water droplets have evaporated completely.

- Place the CF card in the supplied case for storage.
- Do not use or store CF cards in the following types of locations.
 - Locations subject to dust or sand
 - Locations subject to high humidity and high temperatures

Microdrives are a recording medium with a hard disk. Their merits are a large capacity and a low price per megabyte of capacity. However, they can be more susceptible to vibrations and shocks than CF cards, which use durable flash memories. Please be careful, therefore, not to subject the camera to vibrations or shocks when using a microdrive, especially while recording or playing back.

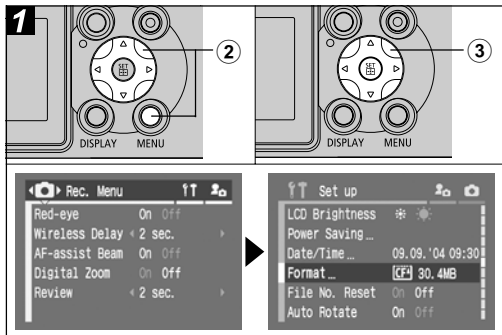
Formatting a CF Card

You should always format a new CF card or one from which you wish to erase all images and other data.

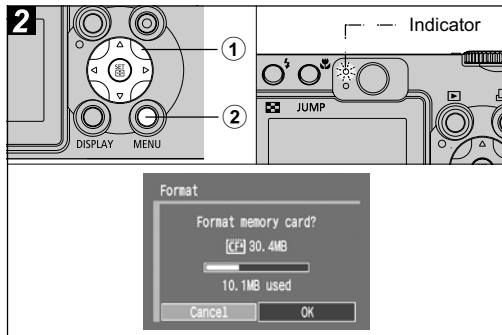
 Please note that formatting (initializing) a CF card erases all data, including protected images and other file types. Please check the contents of the CF card before formatting it.



- ◆ If the camera does not work properly, the inserted CF card may be malfunctioning. Reformatting the CF card may solve the problem.
- ◆ When a non-Canon brand CF card is malfunctioning, reformatting it may solve the problem.
- ◆ CF cards formatted in another camera, computer or peripheral device may not operate correctly. When that happens, reformat the CF card with this camera. If formatting in the camera does not work properly, turn the camera off and reinsert the CF card. Then turn the camera back on and format again.
- ◆ The capacity of the CF card displayed after formatting will be less than the rated capacity of the CF card. This is not a malfunction of the CF card or camera.



- ① Turn the power on (p. 21).
- ② Press the **MENU** button, and then the **▶** arrow on the omni selector.
The [**T**] (Set up) menu appears.
- ③ Select [**Format**] using the **▲** or **▼** arrow on the omni selector, then press the **SET** button.



- ① Select [**OK**] using the **◀** or **▶** arrow on the omni selector, then press the **SET** button.
The upper indicator blinks green, and formatting starts. Wait until the indicator goes off.
 - To cancel instead of formatting, select [**Cancel**] and press the **SET** button.
- ② Press the **MENU** button.

Turning the Power On/Off

The power/mode indicator remains lit while the power of the camera is on. The power/mode indicator indicates the state of the camera as follows.

Orange: Shooting mode

Green: Playback mode/Printer connection mode*

Yellow: Computer connection mode*

Off: The power of the camera is off.

* For printer connection mode, see the *Direct Print User Guide*. For computer connection mode, see the *Software Starter Guide*.

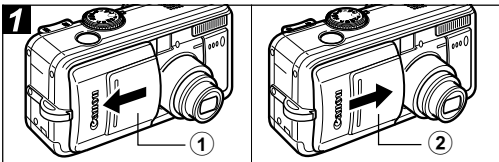


- ◆ You will hear a start-up sound and see the start-up image when the power comes on (p. 113).
- ◆ The start-up image does not appear when the viewfinder display is on in Shooting mode or the A/V OUT terminal is connected to a TV.

Turning on the camera without the start-up sound and image

Press and hold the  button, then turn on the power.

Turning On the Camera in Shooting Mode

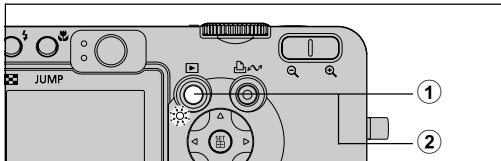


① Open the lens cover.

The power/mode indicator lights orange.

② Close the lens cover to turn the power off.

Turning On the Camera in Playback Mode



① Press the (Playback) button.

When the power is turned on, the power/mode indicator lights green.

② Press the (Playback) button again to turn the power off.

Switching between Shooting and Playback

You can quickly switch between Shooting mode and Playback mode. This is convenient when you wish to shoot again after checking or deleting an image immediately after it is shot.

Shooting Mode Playback Mode

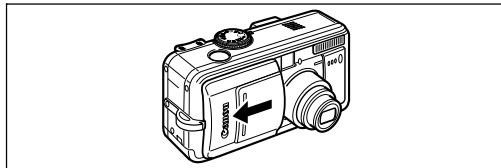
Press the  (Playback) button (p. 42).

- The camera switches to Playback mode, but the lens does not retract (the lens will retract if you close the lens cover).

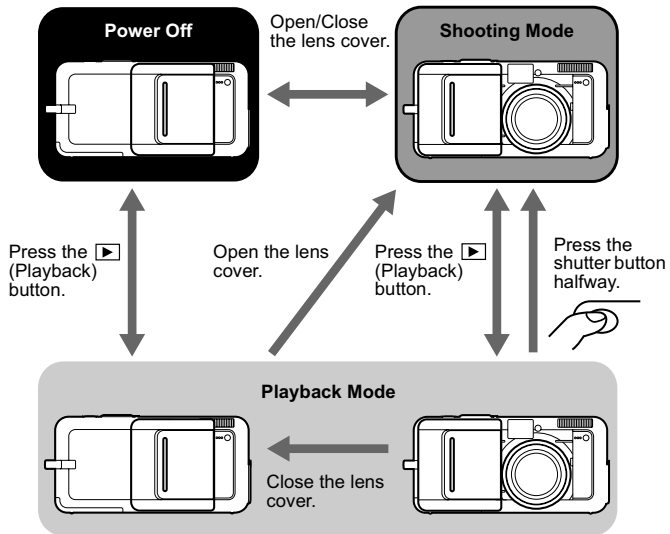
Playback Mode Shooting Mode

Open the lens cover.

When the lens cover is already open, press the shutter button halfway.





Switching between Shooting Mode and Playback Mode



Setting the Date/Time

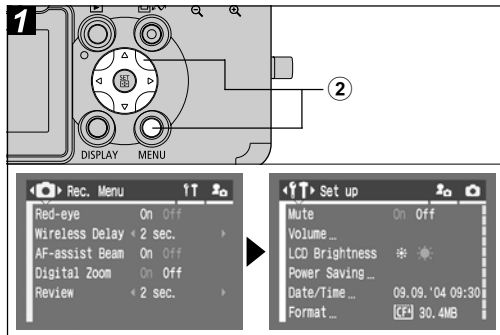
The first time the camera power is turned on or whenever the built-in rechargeable lithium battery charge is low, start from Step 3.

 You may need to reset the date and time if the battery pack is removed for about three weeks.

 ♦ Setting the date and time settings does not cause the date/time stamp to appear on images. For printing images with the date on them, refer to the *Direct Print User Guide* or *Software Starter Guide*.

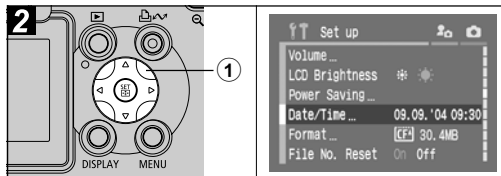
Charging the Date/Time Battery

- ♦ The camera has a built-in rechargeable lithium battery that maintains the date, time and other camera settings. This battery recharges when the main battery pack is inserted into the camera. When you first purchase the camera, place a charged battery pack in it or use the AC Adapter Kit ACK700 (sold separately) for at least 4 hours to charge the date/time battery. It will charge even when the camera power is set to Off.
- ♦ If the Set Date/Time menu appears when the camera power is turned on, it means that the date/time battery charge is depleted. Recharge it as described above.

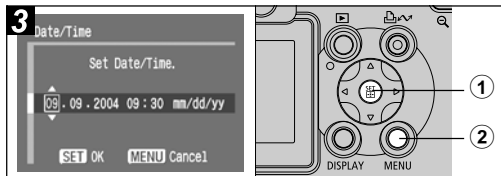


- ① Turn the power on (p. 21).
- ② Press the MENU button, and then the ► arrow on the omni selector.

The [f] (Set up) menu appears.



① Select [Date/Time] using the ▲ or ▼ arrow on the omni selector, then press the SET button.

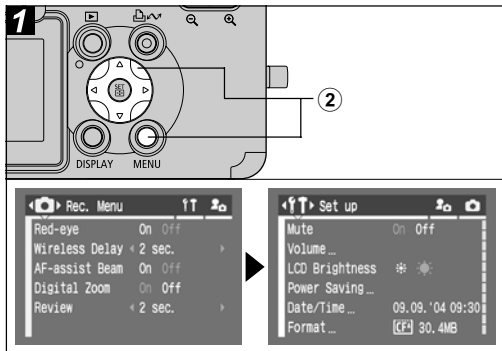


① Set the date and time and press the SET button.

- Select the item you wish to set using ◀ or ▶ and set its value using the ▲ or ▼ arrow on the omni selector.
- The date can be set up to the year 2030.

② Press the MENU button.

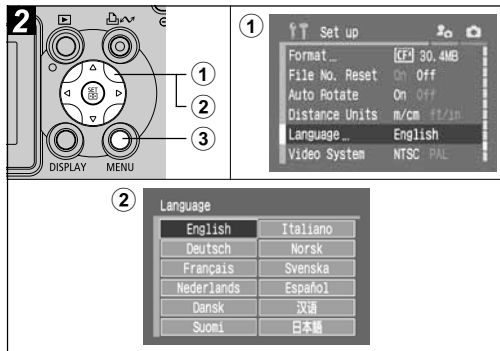
Setting the Language



- ① Turn the power on (p. 21).
- ② Press the **MENU** button, and then the **▶** arrow on the omni selector.

The [Set up] menu appears.

- In Playback mode, you can change the language by holding the **SET** button while you press the **JUMP** button. This function cannot be used during movie playback or during a printer connection.

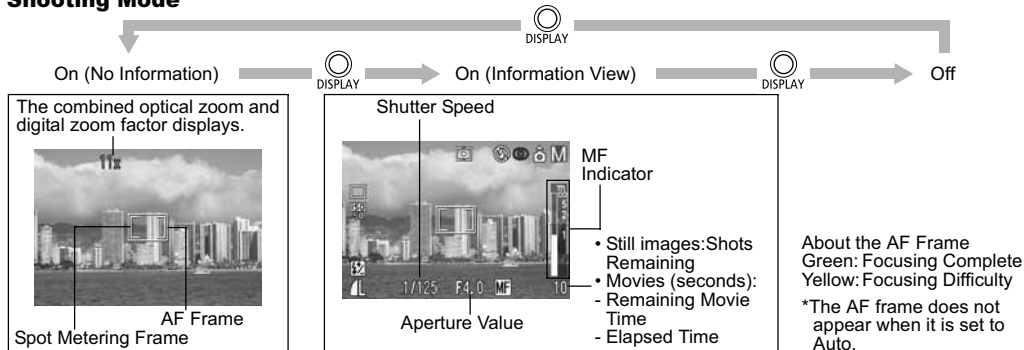


- ① Select [Language] using the **▲** or **▼** arrow on the omni selector, then press the **SET** button.
- ② Select a language using the **▲**, **▼**, **◀** or **▶** arrow on the omni selector, then press the **SET** button.
- ③ Press the **MENU** button.

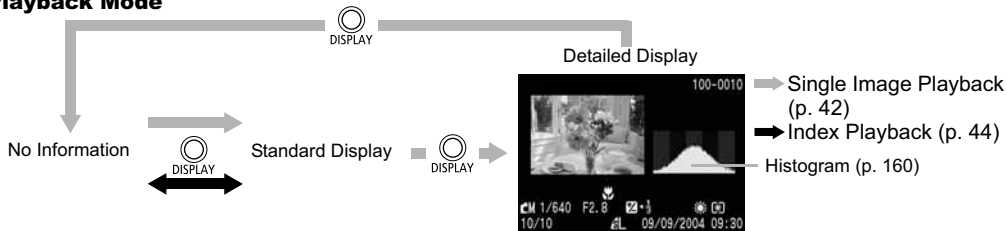
Using the LCD Monitor

Pressing the **DISPLAY** button switches the LCD monitor display mode.

Shooting Mode



Playback Mode



Display Contents

Function	Icon	Shooting Mode		Playback Mode		Reference Page
		Information View	No Information	Detailed Display	Standard Display	
Shooting Modes		○	-*1	○*2	-	p. 48, 72
Exposure Compensation	-2 - +2	○	-	○*3	-	p. 80
AE Lock/FE Lock		○	○	-	-	p. 89, 90
Light Metering Mode		○	-	○	-	p. 78
White Balance (WB)*4		○	-	○	-	p. 81
Drive Mode		○	-	-	-	p. 53, 56, 144
ISO Speed		○	-	○	-	p. 84
Photo Effect		○	-	○	-	p. 85
Bracket		○	-	-	-	p. 86
Flash		○	-	-	-	p. 38
Red-eye Reduction		○	-	-	-	p. 39
Flash Exposure Compensation		○	-	○*3	-	p. 92

Flash Output		○	-	-	-	p. 92
Compression		○	-	○	○	p. 35
Resolution	L M1 M2 S RAW	○	-	○	○	p. 35
Resolution (Movies)		○	-	○	-	p. 35
RAW	RAW	○	-	○	○	p. 57
Digital Zoom*5	3.6x 4.6x 5.8x 7.3x 9.1x 11x 15x	○	○	-	-	p. 54
Zoom Indicator		○	○	-	-	p. 30
Low Battery		○	○	○	○	p. 18
Macro		○	-	○	-	p. 52
Auto Rotate		○	-	-	-	p. 111
Camera Shake Warning		○	○	-	-	p. 29
Manual Focus	MF	○	○	-	-	p. 98
Movie Recording	● (red)	○	○	-	-	p. 58
Sound Memo (WAVE file)		-	-	○	○	p. 103
Movie	AVI	-	-	○	○	p. 60
Protection Status		-	-	○	○	p. 108

*1 (Movie) appears even in No Information display mode.




*2 **C** (Custom) does not appear.

*3 The value for each content also appears.


*4 The icon does not display in Shooting mode.

*5 Zoom powers reflect the combined optical and digital zoom effects. "3.6x" is the telephoto-end setting of the optical zoom.

The following information may also appear with some image files.

	An audio file other than a wave file, or a file with an unrecognized format, is attached.
	JPEG file with format not conforming to Design rule for Camera File System Standards.
	File with unrecognized format.

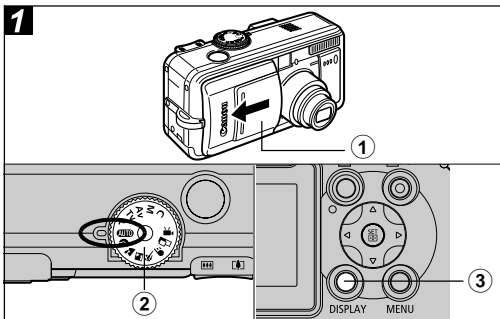


- ◆ Even in the no information display mode, shooting information appears for approximately 6 seconds (shooting information may not appear depending on the camera settings at that time).
- ◆ The camera shake warning icon  will appear on the LCD monitor in low light conditions while the camera is preparing to shoot. When this icon appears, use one of the following shooting methods.
 - Set the flash to On or Auto
 - Fix the camera to a tripod
- ◆ Please note that image information recorded by this camera may not display correctly on other cameras and image information recorded by other cameras may not display correctly on this camera.

◆ **Overexposure Warning**

Overexposed portions of the image blink. The overexposure warning appears at the following times.

- When reviewing an image in the LCD monitor (information view) right after it is shot
- In the detailed display mode of the Playback mode



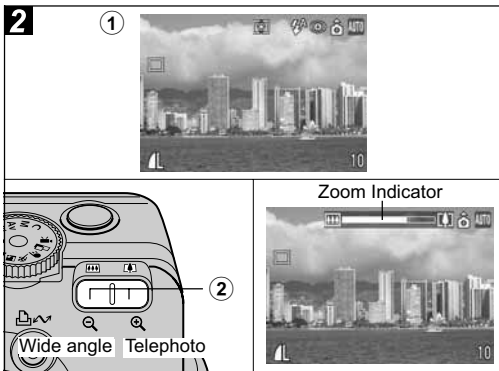
① Open the lens cover.

② Set the shooting mode dial to **AUTO**.

The power/mode indicator lights orange.

- When the lens cover has been opened and the power/mode indicator is lit green, the camera is in the Playback mode. Press the button or press the shutter button halfway to switch to the Shooting mode.

③ If the LCD monitor is not displaying, press the **DISPLAY** button to turn it on.

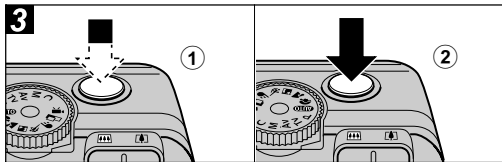


① Aim the camera at the subject.

② Use the zoom to achieve the desired composition in the LCD monitor or viewfinder.

- Press the zoom button's or to display the zoom indicator. Pressing magnifies the subject (telephoto). Pressing decreases the size of the subject (wide angle).

- The angle of view can be adjusted within the 28 to 100 mm range, in 35mm film equivalent.
- The combined use of the digital zoom and optical zoom enables magnified shooting up to approx. 15x (p. 54). The digital zoom cannot be used with some shooting modes (p. 170). Images become coarser the more they are digitally zoomed.



① Lightly press the shutter button halfway to focus.

Two beeps will sound when the camera has finished focusing, and the AF frame on the monitor appears green.

- The AF frame will light yellow and the beep will sound one time if the subject is difficult to focus on. When the AF frame is set to Auto, it will not appear.
- The shutter speed and aperture value are automatically determined and show on the LCD monitor. The exposure compensation (p. 80) and focus are also automatically set.

② Press the shutter button all the way.

You will hear the shutter sound when the shot is complete. Do not move the camera until you hear this sound. The picture appears for two seconds.



- ♦ See page 170 for settings that can be changed in this mode.
- ♦ Images are first saved into the camera's internal memory before being recorded onto the CF card, allowing the next images to be taken immediately as long as sufficient space is available in the internal memory.
- ♦ The upper indicator blinks green while data is recorded onto the CF card.
- ♦ The beep and shutter sound can be set to [On]/[Off] using the menu (p. 68).
- ♦ Shots cannot be taken while the flash is charging.
- ♦ You can change the length of time images show on the LCD monitor after shooting, or set it so they do not show at all (p. 34).

AF-assist Beam

- ♦ The AF-assist beam will sometimes emit when the shutter button is pressed halfway to assist focusing in certain conditions, i.e. dark conditions.
- ♦ The AF-assist beam can be turned off (p. 67). For example, if animals are your subject, turn off the beam when shooting in the dark to

avoid startling them. However, please keep in mind the following facts.

- Turning the AF-assist beam off may make it more difficult for the camera to focus.
- The red-eye reduction lamp may emit when you press the shutter button halfway even if the AF-assist beam is turned off.

In order to prevent any lamp from emitting before the flash fires, set both the red-eye reduction function and the AF-assist beam to [Off] in the Shooting menu.

Using the Viewfinder

Setting the LCD monitor to Off (p. 27) and using the optical viewfinder can help conserve power while shooting.

- ♦ The viewfinder has a field of vision of approximately 80% of the actual shooting image.

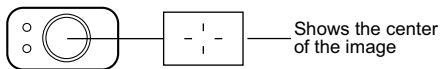


Image Seen in Viewfinder vs. Recorded Image

Please note that the actual image may differ from the image seen in the optical viewfinder

due to the physical separation between the viewfinder and lens. This is called the parallax phenomenon and is more noticeable the closer the subject is to the lens. In some cases, portions of images shot up close that appear in the viewfinder will not appear in the recorded image. Please use the LCD monitor to shoot images up close.

Shooting with an Off-Center AF Frame Selected

You should always use the LCD monitor to compose images when you have selected an off-center AF frame. When setting the AF frame to the desired position to shoot an image, please use the LCD monitor (See *Selecting an AF Frame* → p. 76).

Reviewing an Image Right after Shooting

Shooting Mode Dial



After a photo is taken, the image displays for two seconds (you can change this setting). There are two ways to display the image for longer:

- **Keeping the shutter button pressed**
- **Pressing the SET button while the image is displayed***

Press the shutter button halfway again to stop displaying the image and shoot.

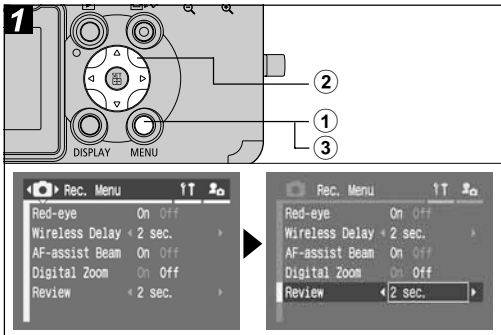


You can perform the following while images are displayed*.

- ◆ Display images in detailed display mode (p. 27)
- ◆ Magnify images (p. 43)
- ◆ Changing the file format (p. 34)
- ◆ Erase images individually (p. 46)
- ◆ Attach sound memos (p. 103)

* Not available in  (Stitch Assist) mode.

Changing the Image Display Duration



- 1 Turn the power on (p. 21), and press the MENU button.

The [RECORD] (Rec.) menu appears.

- 2 Select [Review] using the ▲ or ▼ arrow on the omni selector and select a duration setting using the ◀ or ▶ arrow on the omni selector.

Off: Images do not display

2 to 10 sec.: Images appear for the time selected even if the shutter button is released.

- 3 Press the MENU button.

- You can continue to display the image as long as the shutter button is fully held pressed regardless of the Review setting.
- Another picture can be taken by pressing the shutter button even while an image is displayed.

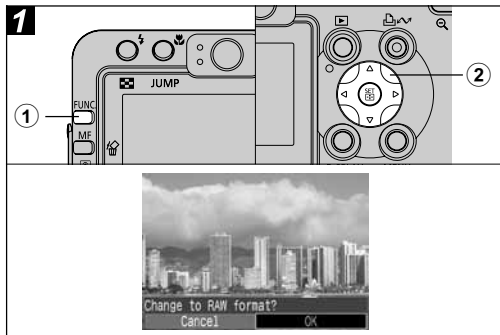
Changing the Recording Format Right after Shooting

Shooting Mode Dial

P Tv Av M

By following the below instructions, you can save images shot in the JPEG format in the RAW format (p. 159) right after shooting. You can easily process images saved in the RAW format using a computer to edit the resolution, photo effect and white balance without any loss of quality.


Changing the Resolution and Compression



① Right after shooting, press the **FUNC.** button while the image is displayed on the LCD monitor.

② Select **[OK]** using ◀ or ▶ arrow on the omni selector and press **SET.**

- When you press the shutter button halfway, the camera returns to the shooting screen.

 The above operations cannot be performed if the image was shot with the digital zoom or when RAW is already selected as the recording format.

Shooting Mode Dial






You can change the resolution, and compression (still images). To record the CCD output without compression, select the RAW file format (p. 57).




Still Images

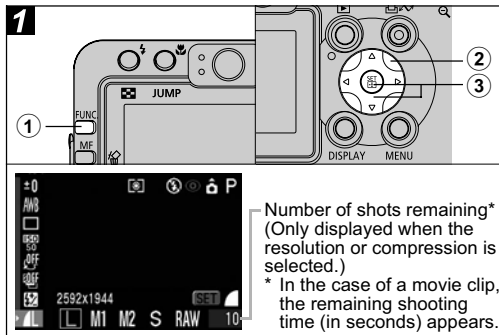
Resolution		Purpose
Display	Pixels	
L (Large)	2592 x 1944	High ● Print A4 size* 210 x 297 mm (8.3 x 11.7 in.) or larger prints ● Print letter size* 216 x 279 mm (8.5 x 11 in.) or larger prints
M1 (Medium 1)	2048 x 1536	● Print A4 size* 210 x 297 mm (8.3 x 11.7 in.) prints ● Print letter size* 216 x 279 mm (8.5 x 11 in.) prints
M2 (Medium 2)	1600 x 1200	● Print postcard size 148 x 100 mm (6 x 4 in.) prints ● Print L size 119 x 89 mm (4.7 x 3.5 in.) prints
S (Small)	640 x 480	Low ● Send images as e-mail attachments ● Shoot more images

* Paper sizes vary according to region.

Compression			Purpose
	Superfine	High Quality	Shoot higher quality images
	Fine	↑ Normal ↓	Shoot normal quality images
	Normal		Shoot more images


Movies

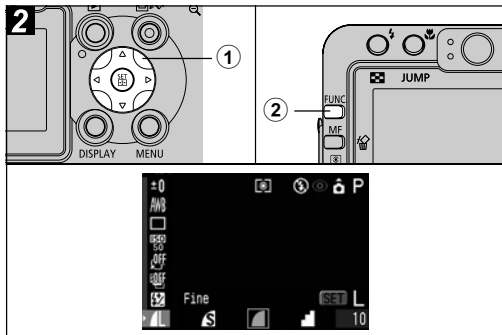
Resolution	
	640 x 480 pixels
	320 x 240 pixels
	160 x 120 pixels



The diagram shows the camera's control panel and LCD screen. On the control panel, the FUNC. button is labeled 1, and the omni-selector is labeled 2 and 3. The LCD screen shows the resolution selection menu with options 640, 320, and 160. The current setting is 2592x1944. The SET button is also visible on the screen.

Number of shots remaining*
 (Only displayed when the resolution or compression is selected.)
 * In the case of a movie clip, the remaining shooting time (in seconds) appears.

- 1 Press the **FUNC.** button.
- 2 Select * (2592 x 1944) using the ▲ or ▼ arrow on the omni selector.
 * The current setting is displayed.
- 3 Select the resolution you wish to set using the ◀ or ▶ arrow on the omni selector, then press the **SET** button.



① Select the compression you wish to set using the ◀ or ▶ arrow on the omni selector.

- You can shoot the image right after selecting settings by pressing the shutter button. This screen will appear again, once the image is shot.
- See *Image File Sizes (Estimated)* (p. 157).
- Types of CF cards and number of shots remaining (p. 156).

② Press the FUNC. button and shoot the image.

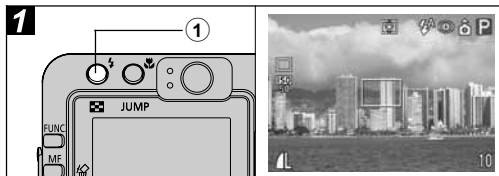
⚡ Using the Flash

Shooting Mode Dial

AUTO

Use the flash according to the guidelines below.

	Auto with red-eye reduction	The flash fires automatically as required by the lighting level, and the red-eye reduction lamp fires each time the main flash fires.
	Auto	The flash fires automatically as required by the lighting level.
	Flash on with red-eye reduction	The red-eye reduction lamp and the flash always fire.
	Flash on	The flash always fires.
	Flash off	The flash does not fire.



① Press the ⚡ button to switch between flash modes and shoot the image.

The selected flash mode appears on the LCD monitor.

- You can switch between settings by pressing the ⚡ button. The flash setting may not switch with certain shooting modes.

When the red-eye reduction function is on



When the red-eye reduction function is off

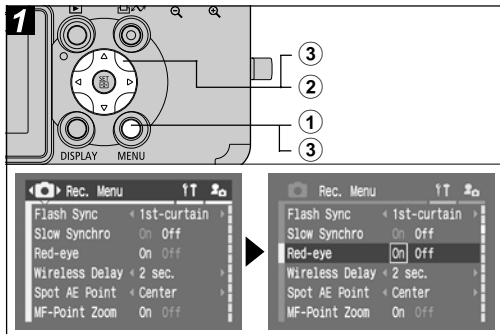


Setting the Red-eye Reduction Function

Shooting Mode Dial

AUTO P Tv Av M

The red-eye reduction lamp fires when the flash is used in dark areas. This reduces light reflecting back from the eyes and making them appear red.



- 1 Turn the camera on in Shooting mode (p. 21) and press the MENU button.

The [] (Rec.) menu appears.

- 2 Select [Red-eye] using the ▲ or ▼ arrow on the omni selector.
- 3 Select [On] using the ◀ or ▶ arrow on the omni selector and press the MENU button.

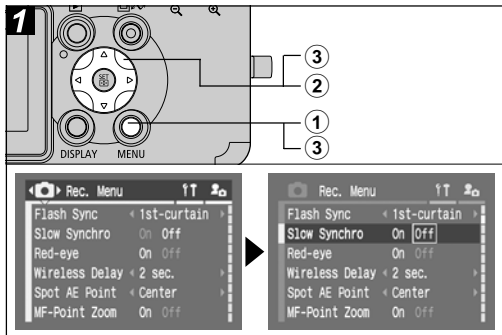
- appears on the LCD monitor if it is set to Information View display.
- When shooting with the red-eye reduction function, the subjects must look right at the red-eye reduction lamp for this mode to be effective. Try asking them to look directly at the lamp. Even better results can be obtained by shooting with the lens set to a wide angle, increasing the lighting in indoor settings or approaching closer to the subject.

Setting the Slow Synchro

Shooting Mode Dial

P Av

You can shoot images using the flash with a slow shutter speed. This helps brighten up dark backgrounds when shooting night scenes or with indoors lighting conditions.



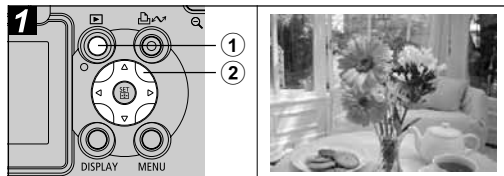
- ① **Power the camera in Shooting mode (p. 21) and press the MENU button.**
The [] (Rec.) menu appears.
- ② **Select [Slow Synchro] using the ▲ or ▼ arrow on the omni selector.**
- ③ **Select [On] using the ◀ or ▶ arrow on the omni selector and press the MENU button.**

! When shooting with a high ISO sensitivity and using the built-in flash, there is more of a chance of overexposure the closer you are to the subject.



- ◆ The flash fires with automatic adjustments when [Flash Adjust] is set to [Auto] in the Rec. menu. When shooting in **M** mode, or with [Flash Adjust] set to [Manual], the flash fires with the manually set adjustments.
- ◆ When [Flash Adjust] is set to [Auto], the flash fires twice. A pre-flash will fire and will be followed by the main flash. The pre-flash is used by the camera to obtain the subject's exposure data so that the main flash can be set to the optimal intensity for the shot.
- ◆ The fastest shutter speed for flash synchronization is 1/250 second. The camera automatically resets the shutter speed to 1/250 second if a faster speed is selected.
- ◆ Shots cannot be taken while the flash is charging.

- ◆ The flash may take up to approximately 10 seconds to charge in some cases. Actual times will vary according to usage and the battery charge.
- ◆ The flash exposure and the flash output can be changed (p. 92).
- ◆ When shooting with [Slow Synchro] set to [On], camera shake may become a factor. We recommend the use of a tripod.
- ◆ The flash setting is saved when the camera is turned off in the **P**, **Tv**, **Av** and **M** shooting modes.








You may not be able to play back images that have been shot with another camera or edited on a computer with other software applications.

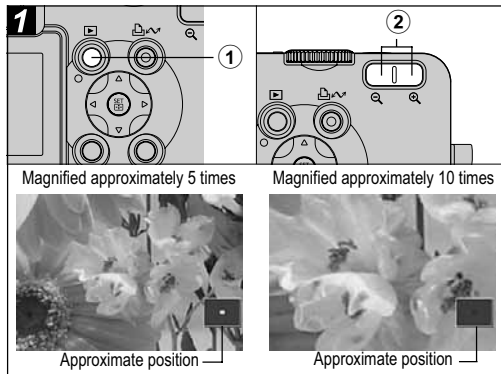
① Press the button.

The last recorded image appears on the LCD monitor.


② Move between images using the or arrow on the omni selector.


- Use  to move to the previous image and  to move to the next. Holding  or  moves more rapidly between images, but the images will not appear as clearly.
- You can also switch images by pressing the **JUMP** button (p. 45).
- Press the **DISPLAY** button to show the data for the displayed image (p. 27).
- Press the  button to quickly delete the displayed image (p. 46).

➤ Magnifying Images







① Press the  button.

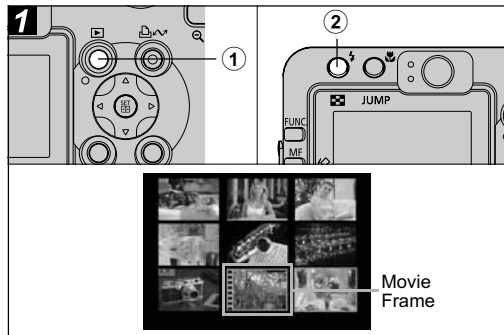
② Press the zoom button's  to magnify the displayed image. Press the  to cancel the magnified display.

- In single image playback, images can be magnified up to 10 times. To change the magnification of an image, while holding down the **SET** button, press the zoom button's .

Each time this is pressed, the magnification will change as follows: approx. 2.5x → approx. 5x → approx. 10x.


- You can move around the magnified image using the , ,  or  arrow on the omni selector.
- Movie frames and index playback images cannot be magnified.
- You can magnify an image while it is displayed on the LCD monitor immediately after the image is shot (p. 34).

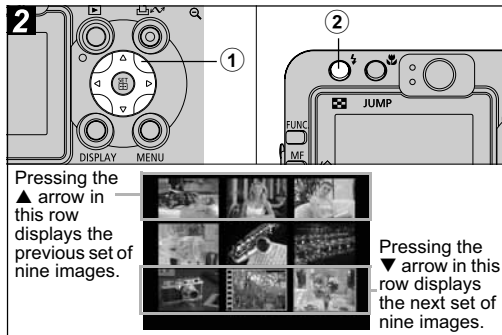
Viewing Images in Sets of Nine (Index Playback)



① Press the  button.

② Press the  button.


- Nine images appear at once (index playback).
- You can switch to index playback by pressing the  button.



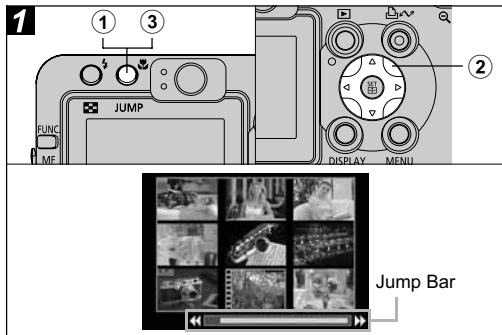
① Change the image selection using the , ,  or  arrow on the omni selector.

- Press the **DISPLAY** button to show the data for the displayed image (p. 27).

② Press the  button.

- Index playback cancels and the display reverts to single image playback.
- You can cancel index playback by pressing the  button.

JUMP Jumping Between Images



- 1 Press the **JUMP** button while in single image playback (p. 42) or index playback (p. 44).

The jump bar appears.

- 2 Change the image selection using the ◀ or ▶ arrow on the omni selector.

- **Single Image Playback:** The 10th image ahead or behind is displayed.

- **Index Playback:** The previous or next 9 images are displayed.

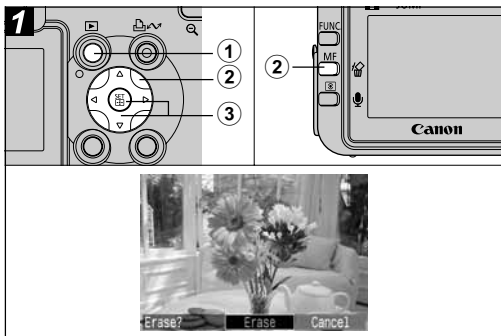
- 3 Press the **JUMP** button.

The jump bar disappears and the camera reverts to single image playback or index playback.

4. Erasing

Erasing Images Individually

Please note that erased images cannot be recovered. Exercise caution before erasing a file.



① Press the button.

The last recorded image appears on the LCD monitor.

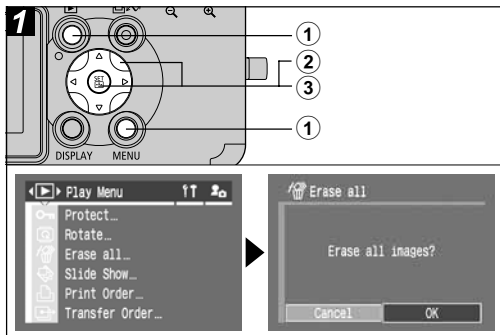
② Select the image you wish to erase using the or arrow on the omni selector and press the button.

③ Select [Erase] using the or arrow on the omni selector and press the SET button.


- To cancel instead of erasing, select [Cancel].
- Protected images cannot be erased with the erase function (p. 108).





Erasing All Images


Please note that erased images cannot be recovered. Exercise caution before erasing a file.



- 1 Press the  button to set the camera to Playback mode, then press the MENU button.

The [ (Play)] menu appears.

- 2 Select [Erase all] using the  or  arrow on the omni selector, then press the SET button.
- 3 Select [OK] using the  or  arrow on the omni selector, then press the SET button.
 - To cancel instead of erasing, select [Cancel].
 - Protected images cannot be erased with the erase function (p. 108).

 The [Erase all] function erases all the image data recorded on the CF card. You should format the CF card when you want to erase not only image data but also all the data contained on the card (p. 19).

5. Useful Shooting Functions

Using the Shooting Mode Dial (Image Zone)

Settings fitting the shooting conditions of your subject can easily be set using the mode dial.

Landscape



Use this mode to shoot deep and spacious scenes.

Portrait



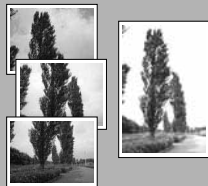
Use this mode when you want the subject to appear sharp and the background to blur.

Movie (p. 58)

Use this mode to shoot movies. Sound is also recorded simultaneously.



Stitch Assist (p. 50)



Use this mode when taking shots that you want to combine into a panorama.



Night Scene



Use this mode to capture human subjects against the backdrop of an evening sky or night scene. The subject is illuminated with light from the flash while the backdrop is captured at a slow shutter speed.

Fast Shutter

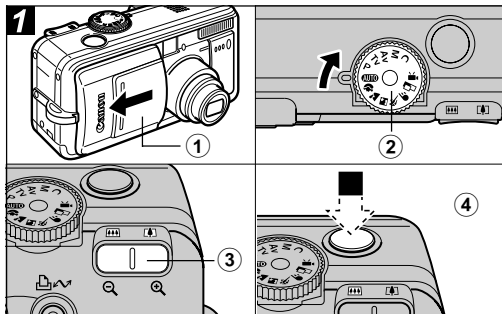


Use this mode to shoot fast moving objects.

Slow Shutter



Use this mode to shoot moving objects to make them appear blurred, such as river rapids.



① Power the camera in Shooting mode (p. 21).

The [RECORD] (Rec.) menu appears.

② Turn the shooting mode dial and set it to the desired function as shown above.


③ Use the zoom button to achieve the desired composition (relative to subject size).

④ Press the shutter button halfway to lock the focus, then press all the way to shoot the image.

- Shooting procedures are the same as for the **AUTO** mode (p. 30).

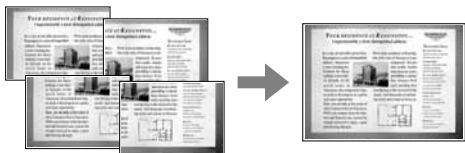
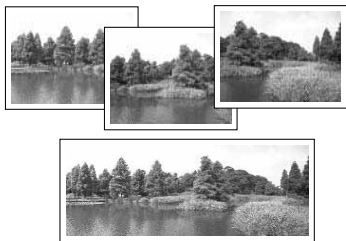


- ♦ See page 170 for settings that can be changed in this mode.
- ♦ The features for each function are shown below.

	You can achieve a better blurring effect of the background by making sure the upper half of your subject fills the entire LCD monitor or viewfinder.
	You can enhance the blurring effect of the background even more by setting the lens to its telephoto end setting.
	The camera shake warning icon  may appear on the LCD monitor since slower shutter speeds are frequently used in this mode. If this happens, affix the camera to a tripod.
	The shutter speed slows down. Even if you use the flash, tell your subjects not to move for a few moments. If the Night Scene mode is used to shoot mid-day shots, the same effects as with the AUTO mode can be obtained.
	The slow synchro option automatically turns on.
	Noise in the image may be more apparent with dark subjects.
	Always use a tripod to prevent camera shake.

Shooting Panoramic Images (Stitch Assist)

Use this mode to shoot a series of overlapping frames for merging (stitching) into a large panoramic image using a computer.



Please use the bundled PhotoStitch program to merge the images on a computer.

Framing a Subject

PhotoStitch detects the overlapping portions of adjoining images and merges them. When composing shots, try to include a distinctive item (landmark, etc.) in the overlapping portions.









- ◆ Compose each frame so that it overlaps 30 to 50% of the adjoining image. Try to keep the vertical misalignment to within 10% of the image height.
- ◆ Do not include moving items in the overlap.
- ◆ Do not try to stitch images that include both distant and close subjects. Objects may appear warped or doubled up.
- ◆ Make the brightness in each image consistent. The final image will appear unnatural if the difference in brightness is too great.
- ◆ For good results, pan (swivel) the camera to take successive shots.

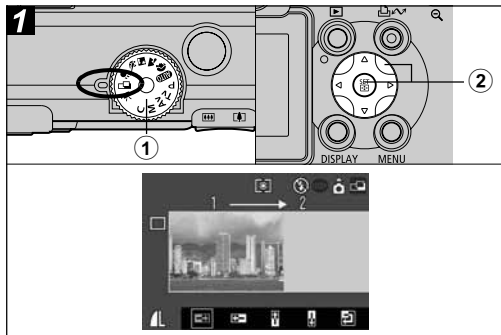
- ◆ To shoot close-ups, slide the camera over the subject, keeping it parallel as you move.


Shooting

Images can be shot in the following 5 sequences in Stitch Assist mode.

	Horizontally, left to right
	Horizontally, right to left
	Vertically, bottom to top
	Vertically, top to bottom
	Clockwise starting at the top left

- ◆ See page 170 for settings that can be changed in this mode.
- ◆ A custom white balance setting (p. 81) cannot be set in  mode. To use a custom white balance setting, first set it in another shooting mode.
- ◆ The settings in place for the first image are locked in and cannot be changed for subsequent shots.
- ◆ A TV cannot be used as the monitor for shooting in this mode.



- 1 Turn the shooting mode dial to .**
The LCD monitor will turn on.
- 2 Select the shooting sequence using the ◀ or ▶ arrow on the omni selector, then press the SET button.**
The shooting sequence is set.
 - You can also press the shutter button directly to shoot without pressing the SET button.
- 3 Shoot the first image.**
 - The exposure and white balance settings are set and locked with the first image.

Macro Mode

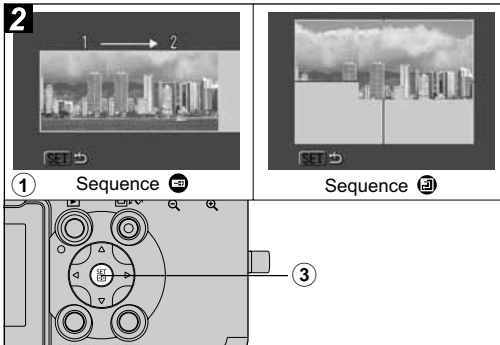
Shooting Mode Dial

AUTO **P Tv Av M**

Use the macro mode to shoot close-ups of subjects in the range of 4 to 44 cm (1.6 in. to 1.4 ft.) at wide angle end and 30 to 44 cm (1.0 ft. to 1.4 ft.) at telephoto end.



- ◆ Always use the LCD monitor to compose images in macro mode. Shooting with the viewfinder is possible, though, the parallax phenomenon may cause images composed with the optical viewfinder to be off-center (p. 32).
- ◆ When the lens is zoomed out to the wide angle end, the recordable area is 64 x 47 mm (2.5 in. x 1.9 in.) at the closest focal distance, and at telephoto end, it is 106 x 80 mm (4.2 in. x 3.1 in.).
- ◆ The exposure may not be optimal when the flash is used in macro mode.

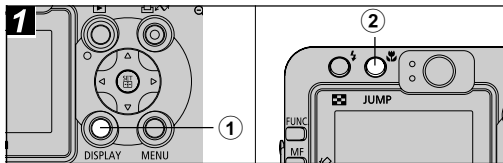


① Compose and shoot the second image so that it overlaps the first.

- Minor discrepancies in the overlap can be corrected with the software.
- An image can be retaken. Press the ◀, ▶, ▲ or ▼ arrow on the omni selector to return to that frame.
- A maximum of 26 images can be recorded either horizontally or vertically.



② Use the same procedures to shoot the remaining frames.

③ Press the SET button after the last shot.



① Press the **DISPLAY** button to turn the LCD monitor on.

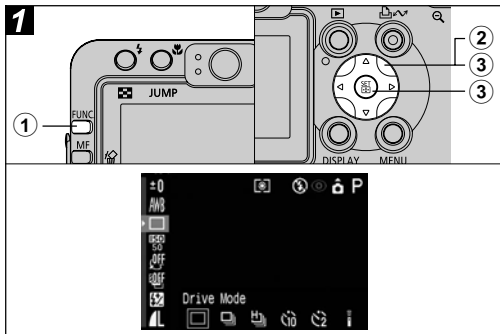
② Press the  button.

- The  icon appears on the LCD monitor.
- Press the  button again to cancel the macro mode.


Using the Self-timer

Shooting Mode Dial


AUTO        **P Tv Av M**








① Press the **FUNC.** button.

② Select * (**Drive mode**) using the **▲** or **▼** arrow on the omni selector.

* The current setting is displayed.

③ Select  or  using the ◀ or ▶ arrow on the omni selector, then press the FUNC. button.

- When the self-timer is set to  () , the shutter activates 10 (2) seconds after the shutter button is pressed fully.
- When  is selected, the self-timer sounds and the self-timer lamp starts blinking when the shutter button is pressed all the way. The blinking gets faster two seconds before the shutter activates.
- When  is selected, the self-timer lamp blinks fast from the beginning. The shutter activates in two seconds.
- You can change the self-timer sound by changing the setting in [Selftimer Sound] in the [ (My Camera)] menu (p. 70).



Digital Zoom

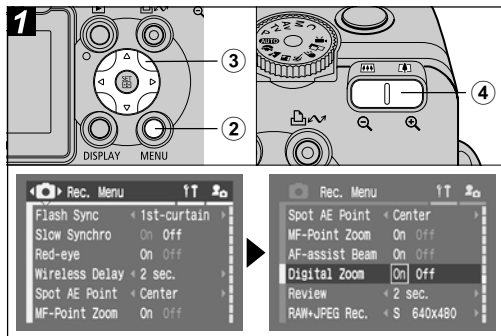
Shooting Mode Dial

      P Tv Av M

With the combined optical and digital zoom functions, images can be zoomed as follows: 4.6x, 5.8x, 7.3x, 9.1x, 11x and 15x.



- ◆ Images become coarser the more they are digitally zoomed.
- ◆ The lens will zoom to the maximum optical telephoto setting and stop. To further zoom the image digitally, press the zoom button's  once more.
- ◆ To zoom back out, press the zoom button's .



- ① Turn the shooting mode dial to any Shooting mode except for or .
- ② Press the MENU button to display the (Rec.) menu.
- ③ Select [Digital Zoom] using the ▲ or ▼ arrow, select [On] using the ◀ or ▶ arrow on the omni selector and press the MENU button.

- ④ Press the zoom button's and shoot the image.

Continuous Shooting

Shooting Mode Dial

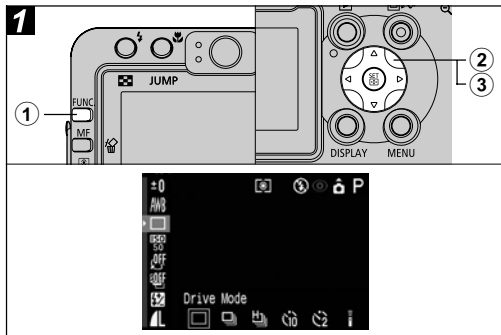


Use this mode to shoot successive frames while the shutter button is fully pressed.

	Standard Continuous Shooting	Use this mode to view the images as you shoot continuously. The shutter interval is longer in this mode than in mode.
	High Speed Continuous Shooting	Use this mode to shoot continuously with a short shutter interval. You cannot check images while shooting continuously.

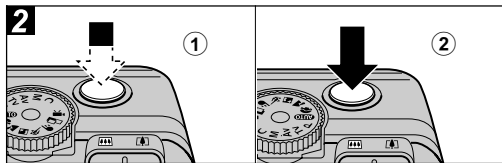


- ♦ The interval between shots may lengthen somewhat when the internal memory becomes full.
- ♦ The flash can be used, but the interval between shots will lengthen to accommodate the flash recharge time.



- 1 Press the **FUNC.** button.
- 2 Select * (**Drive mode**) using the **▲** or **▼** arrow on the omni selector.
* The current setting is displayed.
- 3 Select or using the **◀** or **▶** arrow on the omni selector.


Changing the File Format




- ① Press the shutter button halfway to lock the focus.
- ② Press the shutter button all the way to shoot.

- Shooting will stop when the shutter button is released.

- The shooting speed is as follows.

When  is selected: Approx. 1.5 shots per second*

When  is selected: Approx. 2.0 shots per second*

* Large/Fine mode with LCD monitor off (These figures reflect Canon's testing standard. The actual figures will vary according to the shooting conditions and settings.)

Shooting Mode Dial

P Tv Av M

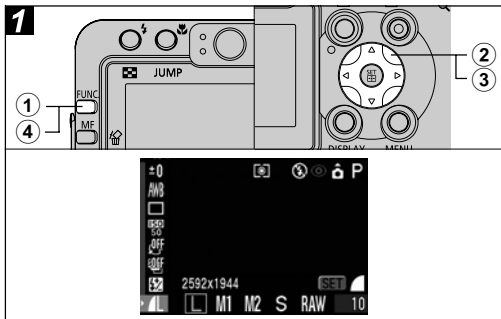
The recording file format can be switched to the RAW format before shooting the image.

When shooting in the RAW format, you can obtain images of the same high quality as those in uncompressed files.

If the RAW format is selected, the number of pixels recorded will be fixed at 2592 x 1944.

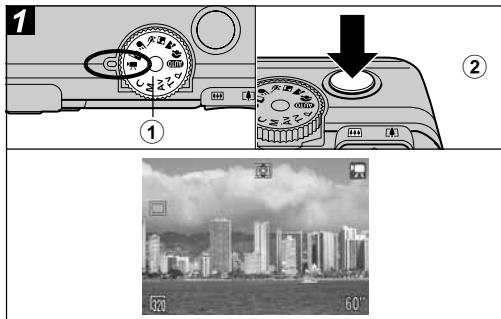


- ◆ See *RAW Format* (p. 159).
- ◆ It is possible to select the resolution of the JPEG image contained in the RAW image. This is useful when displaying enlarged RAW-format images with the camera, or when checking either the focus or for camera shake (p. 67).
- ◆ Images shot in the JPEG format can also be changed to the RAW format while they are displayed right after shooting (p. 34).



- ① Press the **FUNC.** button.
- ② Select **L*** (2592 x 1944) using the **▲** or **▼** arrow on the omni selector.
* The current setting is displayed.
- ③ Select **RAW** using the **◀** or **▶** arrow on the omni selector.
 - You can shoot the image right after selecting settings by pressing the shutter button. The resolution screen will appear again, once the image is shot.
- ④ Press the **FUNC.** button.

Movie Mode



- ① Turn the shooting mode dial to **Movie Mode**.
The maximum recording time (in seconds) appears.
- ② Press the shutter button all the way.
 - During the shooting a red circle appears in the upper right of the LCD monitor.
 - The maximum length of individual movie clips is 30 seconds (10 frames/second) at the **640** setting and 3 minutes (15 frames/second) at the **320** and **160** settings.
The maximum length will vary according to the shooting objects and conditions. The clip will end automatically after this time elapses or when the CF card becomes full.



- The recording time may not display properly during shooting or filming may stop unexpectedly with the following types of CF cards.
 - Slow recording cards
 - Cards formatted on a different camera or a computer
 - Cards which have had images recorded and erased repeatedly

Although the recording time may not display properly during shooting, the movie will be recorded correctly on the CF card. Recording time will display properly if you format the CF card in this camera (excluding slow recording CF cards).

- Be careful not to touch the microphone while shooting.
- If the upper indicator blinks green after a shot, this indicates that the movie is being written to the CF card. You cannot shoot again until it stops blinking.

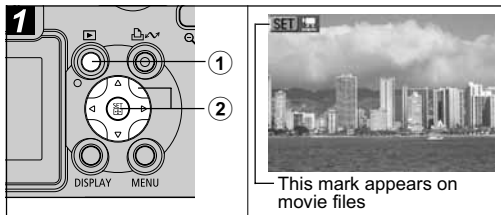


- ◆ See page 170 for settings that can be changed in this mode.
- ◆ See page 35 for resolution information.
- ◆ Sound is recorded monaurally.
- ◆ There is no shutter sound in Movie mode.
- ◆ QuickTime 3.0 or higher is required to play back movie files (AVI/Motion JPEG) on a computer. (QuickTime (for Windows) is bundled on the supplied Digital Camera Solution Disk. On the Macintosh platform, QuickTime 3.0 or later is generally bundled with Mac OS 8.5 or later operating system.)

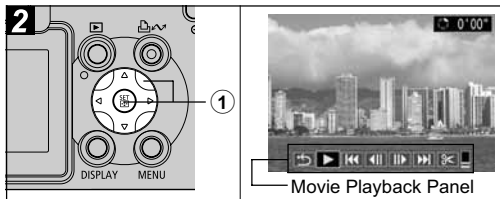
Viewing/Editing Movies

You can play back movies recorded with the Movie mode and delete unwanted portions from the beginning or the end of movie clips.

- Protected movies cannot be edited (p. 108).
- It may take approximately 3 minutes to save an edited movie. If the battery pack runs out of charge partway through, edited movie clips cannot be saved. When editing movies, use a fully charged battery pack or the AC Adapter Kit ACK700 (sold separately).










- ① Press the  button.
- ② Select a movie using the  or  arrow on the omni selector, then press the SET button.



- ① **Select a button from the movie playback panel using the ◀ or ▶ arrow on the omni selector, then press the SET button.**

Movie Playback Panel

-  (Exit): Returns to the screen in Step **1**
-  (Play): Plays back the movie images and sounds
-  (First Frame): Shows the first frame
-  (Previous Frame): Rewinds if the **SET** button is held down
-  (Next Frame): Fast forwards if the **SET** button is held down
-  (Last Frame): Shows the last frame
-  (Edit): Edits the movie → Step **3**

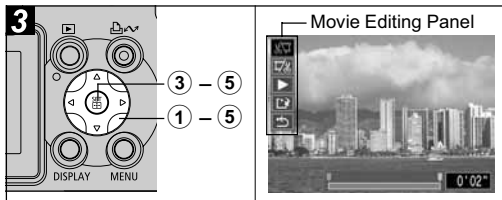
Playback Operations

- ▲▼: Adjusts the volume during playback
- SET**: Pauses playback. Press again to resume playback.






When Playback Ends

The last frame remains displayed when playback ends.

- SET**: Displays the movie playback panel. Press again to play back the movie again from the first frame.
- You may experience frame dropping and audio breakup when playing back a movie on a computer with insufficient system resources.
- The volume at which movies play back can also be adjusted in the Play menu.
- Please adjust the audio sound level on the TV when viewing movie files on a TV.
- If you are not editing the movie, operations end here.



- ① **Select a button from the movie editing panel using the ▲ or ▼ arrow on the omni selector, then press the SET button.**

-  (Cut Beginning): Deletes frames in the first half of the movie
-  (Cut End): Deletes in the second half of the movie
-  (Play): Plays back the temporarily edited movie
-  (Save): Saves the movie
-  (Exit): Cancels movie editing and reverts to the screen in step 2

- Movies with an original length of 1 second or more can be edited in 1-frame units.


- ② **Select the range you wish to delete using the ◀ or ▶ arrow.**

- ③ **Select  using the ▲ or ▼ arrow and press the SET button.**

The temporarily edited movie will start playing.

- The movie will stop if you press the SET button while it is playing.

- ④ **Select  using the ▲ or ▼ arrow and press the SET button.**

- When  is selected, the edited movie is not saved and the camera reverts to the screen in Step 2.

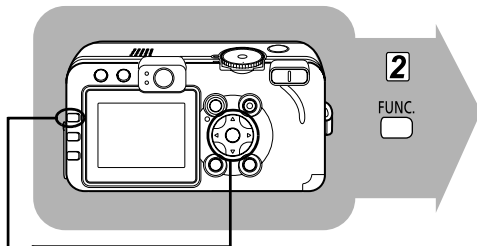
- ⑤ **Select [Overwrite] or [New File] using the ◀ or ▶ arrow and press the SET button.**

[Overwrite]: Saves the edited movie under the same file name as the original movie. The original data is deleted.

[New File]: Saves the edited movie under a new file name. The original data is not deleted.

- When there is not enough space left on the CF card, only the overwrite function is available. If this happens, ▲ appears on the counter of the movie editing bar.

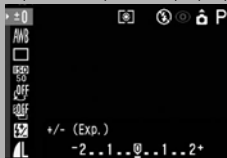
Selecting Settings by Pressing the FUNC. Button (Only in Shooting Mode)



- 1 Select the Shooting mode (p. 21).
- 2 Press the **FUNC.** button.
- 3 Press the **▲** or **▼** arrow to select a function item.
- 4 Press the **◀** or **▶** arrow to select setting contents.
- 5 Press the **FUNC.** button.
- 6 Shoot the image.

- 3 Select a function item using **▲** or **▼**

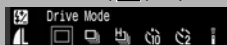
Exposure Compensation (± 0) → p. 80



White Balance ($\frac{WB}{WB}$) → p. 81



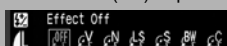
Drive mode (\square) → p. 53



ISO Speed ($\frac{ISO}{50}$) → p. 84



Photo Effect (OFF) → p. 85



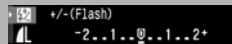
() items in parentheses show default settings.

- 4 Select setting contents using **◀** or **▶**

Bracket (OFF) → p. 86



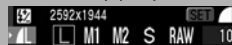
Flash Adjust (± 0) → p. 92



Flash Output → p. 92



Resolution (L) → p. 35



Compression (\blacktriangle) → p. 35



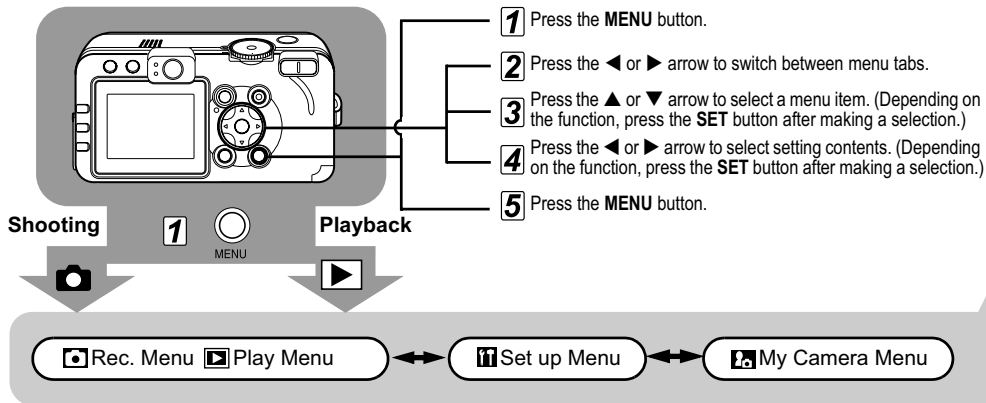
Resolution for Movie ($\frac{320}{320}$) → p. 35



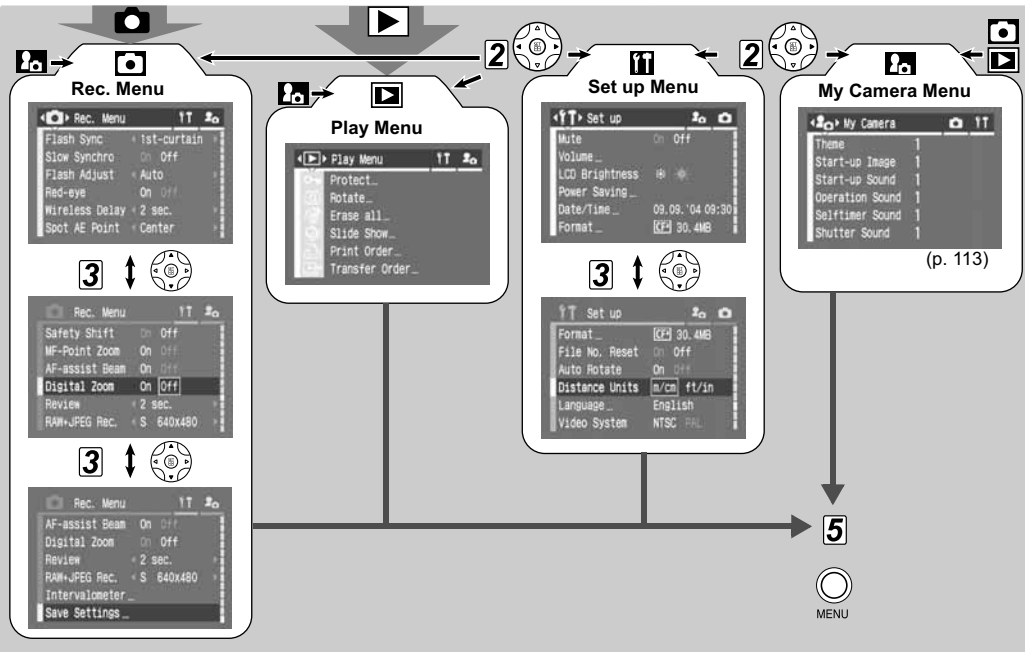
- 5
- FUNC.

- 6
- Shoot the image.

Selecting Settings by Pressing the **MENU** Button



In Shooting mode, the menu can be closed by pressing the shutter button halfway. (If, in the Playback mode, you press the shutter button halfway while the lens cover is open, the menu will close and the camera will switch to Shooting mode.)



(p. 113)



- ◆ Some menu items may not be available for selection according to the shooting mode (p. 170).
- ◆ You can apply a desired image and sound to **[L3]** and **[L8]** in the My Camera menu. For details, see *Registering the My Camera Settings* (p. 114) or the *Software Starter Guide*.
- ◆ Camera settings can be reset to the default values (p. 71).

Rec. Menu

Menu Item	Setting content	Reference Page
Flash Sync	Sets the timing at which the flash fires. 1st-curtain*/2nd-curtain	p. 93
Slow Synchro	Sets whether or not the flash will fire with a slow shutter speed. On/Off*	p. 39
Flash Adjust	Sets whether or not the flash is adjusted automatically. Auto*/Manual	p. 92
Red-eye	Sets whether or not the red-eye reduction lamp fires when the flash fires. On*/Off	p. 39
Wireless Delay	Sets the duration before the self-timer releases the shutter once the remote control shutter button is pressed. 0 sec./2 sec.*/10 sec.	p. 143
Spot AE Point	Sets the option of [Spot AE Point] (one of the light metering modes) to Center (the AE point is fixed to the center) or AE Point (the AE point corresponds to the AF point). Center*/AF Point	p. 78

Menu Item	Setting content	Reference Page
Safety Shift	Adjusts the settings so that the exposure will be appropriate when the shooting mode dial is set to Tv or Av and a shutter speed or aperture value has been set. On/Off*	p. 75
MF-Point Zoom	Sets whether or not the focusing point is magnified when using the manual focus. On*/Off	p. 98
AF-assist Beam	Sets whether or not the AF-assist Beam is activated as needed when using the autofocus. On*/Off	p. 32
Digital Zoom	Sets whether or not the digital zoom combines with the optical zoom to zoom images. On/Off*	p. 54
Review	Sets the duration images display on the LCD monitor (or in the viewfinder) after the shutter button is released. Off/2 sec.* to 10 sec.	p. 34

Menu Item	Setting content	Reference Page
RAW+JPEG Rec.	It is possible to select the resolution of the JPEG image contained in the RAW image. This is useful when displaying enlarged RAW-format images with the camera, or when checking either the focus or for camera shake. Setting the camera to L enables the focus to be checked with greater precision. L/M1/M2/S*	p. 57
Intervalometer	Shoots automatically at set intervals. 2* to 100 shots 1* to 60 min.	p. 94
Save Settings	Saves settings selected in the Rec. menu and the function menu to the mode dial's C mode.	p. 100

* Default setting

Play Menu

Menu Item	Setting content	Reference Page
Protect	Protects images from accidental erasure.	p. 108
Rotate	Rotates images 90 or 270 degrees clockwise in the display.	p. 102

Menu Item	Setting content	Reference Page
Erase all	Erases all images from a CF card (excluding protected images).	p. 47
Slide Show	Plays images in an automated slide show.	p. 104
Print Order	Sets the images that will be printed on a direct print compatible printer or at a photo lab service, the number of copies and other parameters.	p. 128
Transfer Order	Specifies images before downloading to a computer.	p. 133

11 Set up Menu



Menu Item	Setting content	Reference Page
Mute	<p>Set [On] to mute the start-up sound, operation sound, selftimer sound and shutter sound all at once.</p> <ul style="list-style-type: none"> ● If you set [Mute] to [On], no sound will be heard even when any sound item in the My Camera menu is set to 1, 23 or 28 (On). ● Note that the error warning signal beeps even when the Mute setting is [On]. <p style="text-align: center;">On/Off*</p>	-
Volume	Adjusts the volume of camera operations.	-
① Start-up Vol.	Adjusts the Start-up Sound volume when the camera powers up.	p. 21
② Operation Vol.	Adjusts the Operation Sound volume for operation buttons other than the shutter button.	-
③ Selftimer Vol.	Adjusts the volume of the Selftimer Sound informing you that the photo will be taken in 2 seconds.	p. 53
④ Shutter Vol.	Adjusts the Shutter Sound volume when the shutter button is pressed all the way. There is no shutter sound in Movie mode.	p. 31

Menu Item	Setting content	Reference Page
⑤ Playback Vol.	Adjusts the sound volume when a movie or sound memo is played.	p. 60, 103
Settings of Above Items (① - ⑤)	Off <input type="checkbox"/> 1 <input checked="" type="checkbox"/> 2* <input type="checkbox"/> 3 <input type="checkbox"/> 4 <input type="checkbox"/> 5	-
LCD Brightness	Sets the brightness level of the LCD monitor. <input checked="" type="checkbox"/> (Normal)* / <input type="checkbox"/> (Bright)	-
Power Saving	Sets whether or not the camera automatically powers down or the LCD monitor (or viewfinder) goes off after a specified period of time elapses without camera operation. Auto Power Down On*/Off Display Off 10 sec./20 sec./30sec./1 min./2 min./3 min.	p. 109
Date/Time	Sets the date, time and date format.	p. 24
Format	Formats (initializes) a CF card.	p. 19
File No. Reset	Sets how file numbers are assigned to images when new CF cards are inserted. On/Off*	p. 112
Auto Rotate	Sets whether or not images shot with the camera on end are automatically rotated in the display. On/Off*	p. 111





Menu Item	Setting content	Reference Page
Distance Units	Sets the format of the displayed distance units of the MF indicator. m/cm* or ft/in	p. 98
Language	Sets the language used in the menus and messages on the LCD monitor (or in the viewfinder). English*/Deutsch/Français/Nederlands/Dansk/Suomi/Italiano/Norsk/Svenska/Español/Chinese/Japanese You can change the language during image playback by holding the SET button and pressing the JUMP button. (Except when the camera is connected to a printer)	p. 26
Video System	Sets the video output signal standard. NTSC/PAL	p. 124

* Default setting

My Camera Menu

You can select the theme, start-up image and sound, operation sound, selftimer sound and shutter sound used on this camera. These are called My Camera settings. You can also customize the  and  options for each item with images from the CF card and newly recorded sounds or by using the supplied software. See the *Software Starter Guide* for details.

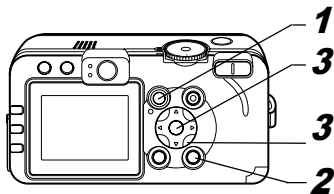
Menu Item	Setting content	Reference Page
Theme	Selects a common theme for each my Camera settings item.	p. 113
Start-up Image	Sets the start-up image when you turn on the camera.	p. 113
Start-up Sound	Sets the start-up sound when you turn on the camera.	p. 113
Operation Sound	Sets the sound when the omni selector or any button other than the shutter button is operated.	p. 113
Selftimer Sound	Sets the sound informing you that the photo will be taken in 2 seconds.	p. 113
Shutter Sound	Sets the shutter sound when you depress the shutter button. There is no shutter sound while a movie is being shot.	p. 113

Menu Item	Setting content	Reference Page
My Camera menu settings content	 (Off) /  * /  / 	—

* Default setting

Resetting the Settings to Default

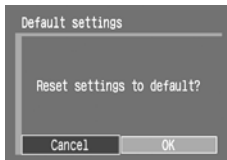
You can reset the menu and button operation settings to default.



1 Open the lens cover or press the  button to power up the camera.

2 Press the MENU button for longer than 5 seconds.

The message "Reset settings to default?" appears on the LCD monitor.



3 Select [OK] using the ◀ or ▶ arrow on the omni selector, then press the SET button.

Resetting starts.

- The normal screen resumes when resetting is complete.
- To cancel resetting, select [Cancel] instead of [OK].



• The following settings cannot be reset to default:

- The [Date/Time], [Language] and [Video System] options in the [F1] (Set up) menu (p. 69)
- White balance data set with the custom white balance function (p. 81)
- Newly registered My Camera settings

• Settings cannot be reset when the camera is connected to a computer or printer.



When the camera is in Shooting mode and the mode dial is set to **C**, only the **C** mode settings will revert to default.

Using the Mode Dial (Creative Zone)

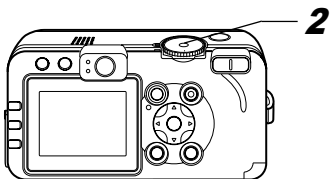
Shooting Mode Dial

P Tv Av M

You can freely select camera settings such as the shutter speed and aperture value to suit your shooting purposes.

After settings are made, shooting procedures are the same as for the **AUTO** mode (p. 30).

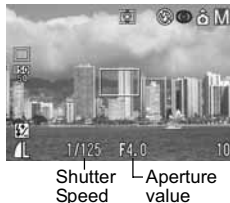
How to Use the Mode Dial



1 Check that the camera is in Shooting mode.

The power/mode indicator lights orange.

2 Turn the shooting mode dial, select the function you wish to use and shoot the image.




- The camera operates in the following ways according to the selected function:

P	The camera automatically sets the shutter speed and aperture value.
Tv	The user selects a shutter speed using the ◀ or ▶ arrow.
Av	The user selects an aperture value using the ◀ or ▶ arrow.
M	The user selects the shutter speed using the ◀ or ▶ arrow and the aperture value using the ▲ or ▼ arrow.

- The shutter speed and aperture value will show on the LCD monitor. The correct exposure has been set if the shutter speed and aperture value show in white on the LCD monitor.

- The shutter speed and aperture value will show in red on the LCD monitor when the correct exposure cannot be obtained.
- When the flash fires, the shutter speed and aperture value will show in white (for all shooting modes except **M**).
- The combinations of shutter speeds and aperture values can be changed within the same exposure setting (p. 73-p. 75).



- ◆ See page 170 for settings that can be changed in this mode.
- ◆ For information on the relation between the aperture value and shutter speed, see page 74.
- ◆ Please note that camera shake becomes a factor at low shutter speeds. If the camera shake warning  appears in the LCD monitor, shoot using a tripod.


P Program AE

Use the program AE mode to have the camera automatically set the shutter speed and aperture value to match the brightness of the scene.

- If a correct exposure cannot be obtained, use the following methods to solve the problem.
 - Use the flash.
 - Change the ISO speed setting.

- Change the light metering mode.

Differences between the P and Modes.

The following settings can be adjusted in **P** mode, but not in  mode.

- Exposure Compensation
- ISO Speed
- Flash Exposure Compensation
- Flash (Flash on, Slow Synchro, 2nd-curtain)
- Photo Effect
- File Format Settings
- Light Metering Mode
- Intervalometer
- FE Lock
- White Balance
- Bracket Mode
- Continuous Shooting
- Manual Focus
- AE Lock

Tv Setting the Shutter Speed

When you set the shutter speed in the shutter speed-priority AE mode, the camera automatically selects an aperture value to match the brightness. Faster shutter speeds allow you to catch an instantaneous image of a moving subject while slower speeds create a flowing effect and allow you to shoot without a flash in dark areas.

- Adjust the shutter speed using the ◀ or ▶ arrow when the image is underexposed (insufficient light) or overexposed (too much light) and the correct exposure cannot be obtained.
- The nature of CCD image sensors is such that noise in the recorded image increases at slow shutter speeds. This camera, however, applies special processing to images shot at shutter speeds slower than 1.3 seconds to eliminate the noise, thereby producing high-quality images. Nevertheless, a certain amount of processing time may be required before the next image can be shot.
- The aperture value and shutter speed change according to the zoom state as follows.

	Aperture value	Shutter Speed (seconds)
Wide Angle End*1	f/2.8 – f/3.5	to 1/1250
	f/4.0 – f/8.0	to 1/2000
Telephoto End*2	f/5.3 – f/7.1	to 1/1250
	f/8.0	to 1/2000

*1 Maximum wide angle

*2 Maximum telephoto

- The fastest shutter speed for flash synchronization is 1/250 second. The camera automatically resets the shutter speed to 1/250 second if a faster speed is selected.

Shutter Speed Display

The numbers in the table below indicate the shutter speed in seconds. 1/160 indicates 1/160 second. Also, quote marks indicate the decimal place, so that 0"3 indicates 0.3 second and 2" indicates 2 seconds.

15"	13"	10"	8"	6"	5"	4"	3"2	2"5	2"	1"6	1"3	1"
0"8	0"6	0"5	0"4	0"3								
1/4	1/5	1/6	1/8	1/10	1/13	1/15	1/20	1/25				
1/30	1/40	1/50	1/60	1/80	1/100	1/125						
1/160	1/200	1/250	1/320	1/400	1/500	1/640						
1/800	1/1000	1/1250	1/1600	1/2000								



About the Safety Shift (p. 75)

AV Setting the Aperture

When you set the aperture in the aperture-priority AE mode, the camera automatically selects a shutter speed to match the brightness.

Selecting a lower aperture value (opening the aperture) allows you to fade the background and create a beautiful portrait. A higher aperture value (closing it) brings the entire range from foreground to background into focus. The larger the aperture value, the greater the range of the image brought into clear focus.

- Adjust the aperture value using the ◀ or ▶ arrow when the image is underexposed (insufficient light) or overexposed (too much light) and the correct exposure cannot be obtained.
- Some aperture values cannot be selected depending on the zoom position.
- In this mode, the maximum shutter speed with synchronized flash is 1/250 second. The aperture value setting may therefore be changed automatically to match the synchronized flash speed even if its value was set previously.

Aperture Setting Display

The larger the aperture value, the smaller the lens aperture.



f/2.8	f/3.2	f/3.5	f/4.0	f/4.5	f/5.0	f/5.3	f/5.6	f/6.3
f/7.1	f/8.0							



About the Safety Shift (p. 75)

Manually Setting the Shutter Speed and Aperture

You can manually set the shutter speed and aperture to achieve a particular effect. This is convenient for shooting fireworks and other images where it is difficult to set the correct exposure automatically.

- The brightness of the LCD monitor matches the selected shutter speed and aperture value. When you select a fast shutter speed or shoot a subject in a dark place and set the flash to  (Flash On (red-eye reduction)) or  (flash On) the image will always be bright.
- When you press the shutter button halfway, the difference between the standard exposure* and the selected exposure appears on the LCD monitor. If the difference is more than 2 stops, "-2" or "+2" appears on the LCD monitor.


* The standard exposure is calculated by the AE function according to the selected metering method.

About the Safety Shift

Shooting Mode Dial

Tv Av

When the Safety Shift has been turned on (p. 67), it may not be possible to obtain an appropriate exposure with a shutter speed and aperture value that have been set manually. In such a case, the settings will automatically be adjusted so that they fall within the range for an appropriate exposure.

 When the flash fires, the settings will be automatically adjusted even if Safety Shift has been turned off.

Selecting an AF Frame

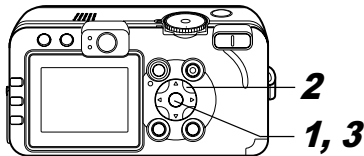
The AF frame indicates the area of the composition on which the camera focuses. You can set the AF frame in the following way.

- For selecting AiAF (auto selection) or a center-point AF frame, see below.
- For selecting a desired position for the AF frame, see p. 77.

Shooting Mode Dial



You can set the AF frame to Auto Selection (AiAF) or to center-point. When Auto Selection (AiAF) is selected, the camera automatically selects an AF frame from 9 points to focus according to the shooting conditions. With the digital zoom, the center-point AF-frame is always selected.



1 Press the button.

The AF frame appears in green on the LCD monitor.

2 Select the auto selection or center-point AF frame using the ▲, ▼, ◀ or ▶ arrow on the omni selector.




e.g. Auto Selection



e.g. Center-point

3 Press the button.

- You can immediately shoot the image using the selected AF frame by pressing the shutter button instead of pressing the  button.

Shooting Mode Dial

P Tv Av M

You can move the AF frame manually to the desired position. This is convenient for focusing accurately on your chosen subject to obtain the composition you desire. The AF frame is fixed to center-point when an image is shot using the viewfinder with the LCD monitor off or when using the digital zoom, even if you previously set the AF frame to the position you desire.



1 Press the button.

The AF frame appears in green on the LCD monitor.

2 Move the AF frame to the position you wish to set using the ▲, ▼, ◀ or ▶ arrow on the omni selector.



3 Press the button.

- You can immediately shoot the image using the selected AF frame by pressing the shutter button instead of pressing  button.
- The AF frame will move back to its original position (Center), if you hold down the  button.






- Turn the LCD monitor on to set the AF frame to the position you desire before shooting.
- The AF frame is locked to center-point when using the digital zoom.
- When the Spot AE Point is selected as the light metering mode, you can use the selected AF frame as the Spot AE Point (p. 78).
- For an explanation of the AF frame colors, please refer to p. 27.

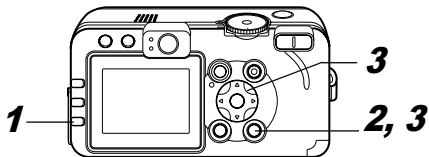
Switching between Light Metering Modes

Shooting Mode Dial

P Tv Av M

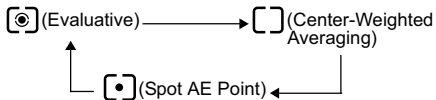
Evaluative metering is the default light metering mode. This can be switched to another metering mode.




	Evaluative Light Metering	The camera divides images into several zones for light metering. The camera evaluates the complex lighting conditions, such as the position of the subject, the brightness, the background, the direct light, and the backlighting, and adjusts the settings to the correct exposure for the main subject. This mode is particularly well-suited for backlit conditions and general photography.
	Center-Weighted Averaging	Averages the exposure from the entire image, but places more weight on the subject at the center.
	Spot AE Point	Meters the area within the spot AE point frame.
	Center	Locks the spot metering frame to the center of the LCD monitor.
	AF Point	Moves the spot AF point to the AF frame.



1 Press the button to select a metering mode.

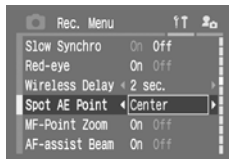
- Each press of the  button changes the metering mode as follows.



- The icon of the currently selected light metering mode appears on the LCD monitor. If you have selected  (Spot AE point), go to step 2. If you have selected  (Evaluative Light Metering) or  (Center-Weighted Averaging), shoot the image.

2 In the (Rec.) menu, select **[Spot AE Point]**.

- See *Selecting Menus and Settings* (p. 64).



3 Select **[Center]** or **[AF Point]** using the or arrow, then press the **MENU** button.

- When [Spot AE point] is set to [Center], the spot AE point frame appears at the center of the LCD monitor, and when [Spot AE Point] is set to [AF point], it appears inside the selected AF frame.



e.g. Center

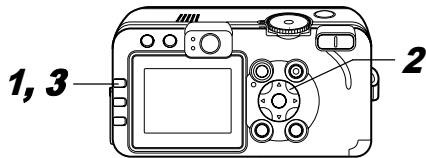
Spot AE Point

Adjusting the Exposure


Shooting Mode Dial



When, due to the shooting conditions, the image displayed appears lighter or darker than the actual photographic subject, adjust the exposure compensation setting.



1 Press the FUNC. button.

2 Select * (+/- (Exp.)) using the ▲ or ▼ arrow, and set the exposure using the ◀ or ▶ arrow.



* The current setting is displayed.

- The settings can be adjusted in 1/3-stops in the range of -2 stops to +2 stops.
- You can shoot the image right after selecting settings by pressing the shutter button. This screen will appear again, once the image is shot.

3 Press the FUNC. button.

- To cancel the exposure compensation, return the setting to 0 using the ◀ or ▶ arrow.

WB Adjusting the Tone (White Balance)

Shooting Mode Dial



When the white balance mode is set to match the light source, the camera reproduces colors more accurately.

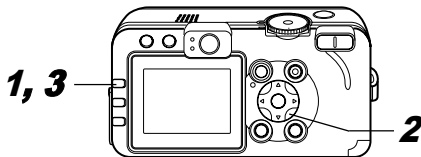
Combinations of setting contents and light source are as follows.

	Auto	Settings are automatically set by the camera
	Daylight	For recording outdoors on a bright day
	Cloudy	For recording under overcast, shady or twilight skies
	Tungsten	For recording under tungsten and bulb-type 3-wavelength fluorescent lighting
	Fluorescent	For recording under warm-white, color-white or warm-white (3-wavelength) fluorescent lighting
	Fluorescent H	For recording under daylight fluorescent, or daylight fluorescent-type 3-wavelength fluorescent lighting
	Flash	For flash photography
	Underwater	For shooting under water using the Waterproof Case WP-DC40 (sold separately).



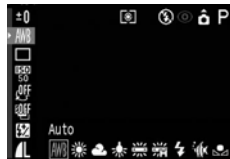
Custom

For setting a custom value with a white sheet of paper, etc., to obtain the optimal white balance for the conditions.



1 Press the FUNC. button.




2 Select **AWB*** (Auto) using the **▲** or **▼** arrow and select the desired setting using the **◀** or **▶** arrow.




* The current setting is displayed.

- Please see page 82 regarding the custom setting.
- You can shoot the image right after selecting settings by pressing the shutter button. This screen will appear again, once the image is shot.

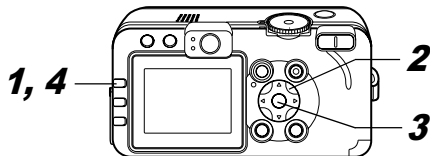
3 Press the FUNC. button.

 The white balance cannot be adjusted when the photo effect is set to  (Sepia) or  (B/W) (p. 85).

Setting a Custom White Balance

In the following cases, the white balance may not be correctly adjusted. Use  (Custom) to adjust the white balance.

- Shooting at close distances (macro)
- Shooting subjects of monotone color (such as sky, sea or forest)
- Shooting with a peculiar source of light (such as a mercury-vapor lamp)



1 Press the FUNC. button.

2 Select * (Auto) using the or arrow and select (Custom) using the or arrow.

* The current setting is displayed.

3 Aim the camera at a white paper or cloth, or gray card and press the SET button.

The white balance data is recorded.

- Aim the camera so that the white paper or cloth, or gray card, completely fills the center of the frame.
- You can shoot the image right after selecting settings by pressing the shutter button. The menu displays again after the shot, allowing you to change the settings easily.

4 Press the FUNC. button.





◆ You are recommended to set the white balance when shooting in the following conditions.


- **The shooting mode is set to P and the exposure compensation and flash exposure adjustment are set to ± 0 .**

The correct white balance may not be obtained when the exposure is incorrect (image is completely black or white).

- **The zoom is positioned to the telephoto end setting.**




Set the digital zoom to [Off].

- **A mode other than  is selected.**

In  mode, white balance data cannot be read.

- **The flash is set to  (Flash On) or  (Flash Off).**

Use the same flash setting as the one that will be used for shooting when you set the white balance. If the white balance setting conditions and shooting conditions are not the same, the correct white balance may not be obtained.

When the flash is set to   (Auto with red-eye reduction) or  (Auto), the flash may fire

while the white balance data is recorded to the custom white balance. If this happens, make sure the flash also fires when you shoot the image.

- **The ISO speed is set to the same setting to shoot the image.**
- ◆ The custom white balance will not be canceled even if you reset camera settings to default (p. 71).

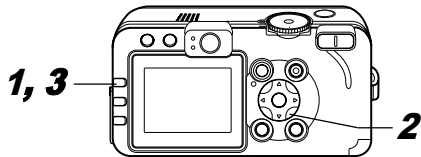
ISO Changing the ISO Speed

Shooting Mode Dial

P Tv Av M

By raising the ISO speed, you can shoot bright images even in poor lighting conditions. This function is convenient when you want to prevent camera shake, shoot without the flash or shoot with a faster shutter speed in dark conditions.

You can choose from the following speeds: Auto, 50, 100, 200 and 400.



1 Press the FUNC. button.

2 Select **ISO*** (ISO Speed) using the **▲** or **▼** arrow and select the desired setting using the **◀** or **▶** arrow.



* The current setting is displayed.

- You can shoot the image right after selecting settings by pressing the shutter button. The menu displays again after the shot, allowing you to change the settings easily.

3 Press the FUNC. button.



- Higher ISO speeds increase the image noise. To take clean images, use as low an ISO speed as possible.
- The AUTO setting selects the optimal ISO speed. It will automatically raise the speed when the light from the flash is insufficient to illuminate the subject matter.

📷 Changing the Photo Effect

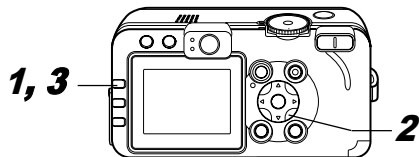
Shooting Mode Dial



You can shoot with different saturation and contrast effects.

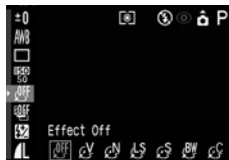
	Photo Effect Off	Records with no effect.
	Vivid	Emphasizes the contrast and color saturation to record in bold color.
	Neutral	Tones down the contrast and color saturation to record neutral hues.
	Low Sharpening	Records subjects with softened outlines.
	Sepia	Records in sepia tones.
	B/W	Records in black and white.
	Custom Effect*	You can freely set the contrast, sharpness and color saturation.

* **P**, **Tv**, **Av** and **M** modes only



1 Press the **FUNC.** button.

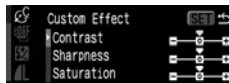
2 Select * (Effect Off) using the ▲ or ▼ arrow and select the desired setting using the ◀ or ▶ arrow.



* The current setting is displayed.

When is selected

- A screen allowing you to set the contrast, sharpness and color saturation appears when you press the **SET** button. Select the item you wish to set using the ▲ or ▼ arrow, set it using the ◀ or ▶ arrow and press the **SET** button.



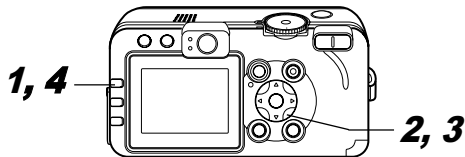
Auto Exposure Bracketing (AEB Mode)

Shooting Mode Dial

P Tv Av

In this mode, the camera automatically changes the exposure within a set range to take three shots after you press the shutter button once.

You can adjust AEB settings in 1/3 stops within the range of -2 stops to +2 stops of the standard exposure setting. AEB settings can be combined with exposure compensation settings (p. 80) to extend the adjustment range. The images are recorded in the following order: Standard exposure, underexposure and overexposure.



1 Press the FUNC. button.

- You can shoot the image right after selecting settings by pressing the shutter button. The menu displays again after the shot, allowing you to change the settings easily.

Contrast

- This function allows you to adjust the degree of brightness.
- Select from - (Weak), 0 (Neutral) and + (Strong).

Sharpness



- This function allows you to adjust how sharply outlines are defined.
- Select from - (Weak), 0 (Neutral) and + (Strong).

Saturation

- This function allows you to adjust the color depth.
- Select from - (Weak), 0 (Neutral) and + (Strong).

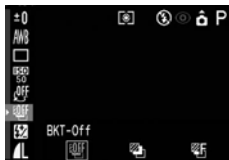
3 Press the FUNC. button.




The white balance cannot be set when  (Sepia) or  (B/W) mode is selected.

2 Select * (BKT-Off) using the ▲ or ▼ arrow.

* The current setting is displayed.




3 Select , press the SET button and adjust the compensation range using the ◀ or ▶ arrow.



- Use ▶ to expand the range and ◀ to contract it.
- You can shoot the image right after selecting settings by pressing the shutter button. The menu displays again after the shot, allowing you to change the settings easily.

4 Press the FUNC. button.

- Select  (BKT-Off) in Step **3** to cancel the AEB mode.



The AEB mode cannot be used for flash photography. If the flash fires, only one image gets recorded.

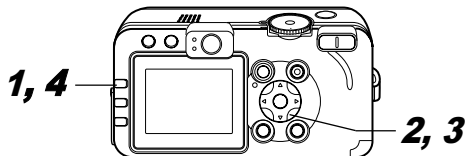
Focus Bracketing (Focus-BKT Mode)

Shooting Mode Dial

P Tv Av M

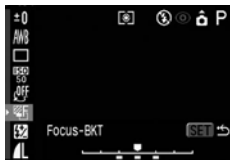
You can shoot three images while the focus changes automatically when shooting with the manual focus.

Three ranges -small, medium or large- can be selected. Images are shot with the focus position changing in the following order; current position, backwards and forward.



1 Press the FUNC. button.

- 2** Select **OFF*** (BKT-Off) using the **▲** or **▼** arrow, select **Focus-BKT** using the **◀** or **▶** arrow and press the **SET** button.



* The current setting is displayed.

- 3** Select a range using the **◀** or **▶** arrow.



- Use **▶** to expand the range and **◀** to contract it.
- You can shoot the image right after selecting settings by pressing the shutter button. The menu displays again after the shot, allowing you to change the settings easily.

- 4** Press the **FUNC.** button and shoot the image with the manual focus (p. 98).

- Select **OFF** (BKT-Off) in Step **2** to cancel the Focus-BKT mode.



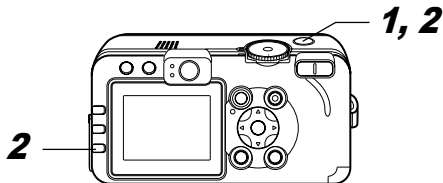
The Focus-BKT mode is not available when shooting with the flash on. The camera will revert to shooting only one image when the flash is on.

Locking the Exposure Setting (AE Lock)

Shooting Mode Dial


P Tv Av

You can set the exposure and focus separately. This is effective when the contrast is too strong between the subject and background or when a subject is backlit.



1 Focus the AF frame or the spot metering frame on the subject on which you wish to lock the exposure setting and press the shutter button halfway.

- See *Selecting and AF Frame* (p. 76)
- See *Switching between Light Metering Modes* (p. 78)

2 While pressing the shutter button halfway, press the  button.

- The exposure setting locks (AE Lock) and the * icon appears on the LCD monitor.
- Using any button other than the omni selector cancels the AE lock.



AE lock

3 Recompose the image and shoot.


The camera focuses on the subject in the AF frame.



The automatically selected combinations of shutter speeds and aperture values can be freely changed without altering the exposure with the following procedures.

1. Turn the mode dial to **P**, **Tv** or **Av**.
2. Focus on the subject on which you wish to lock the exposure and press the shutter button halfway.

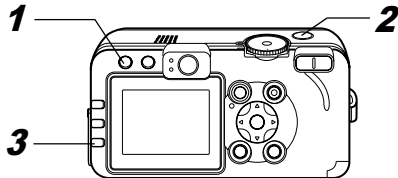
Locking the Flash Exposure Setting (FE Lock)


3. Press the  button.
The exposure setting will lock and the * icon will appear in the LCD monitor.
4. Press the ◀ or ▶ arrow until the desired shutter speed or aperture value is reached.
5. Recompose the image and shoot. The setting will cancel after the shot is taken.

Shooting Mode Dial


P Tv Av

You can obtain the correct exposure regardless of the location of your subject in the composition.




- 1** Press the  button and set the flash to fire (p. 38).
- 2** Focus the AF frame or the spot metering frame on the subject on which you wish to lock the flash exposure setting and press the shutter button halfway.

3 While pressing the shutter button halfway, press the button.

- The flash exposure compensation setting locks (FE Lock) and the * icon appears on the LCD monitor.
- The flash will fire a pre-flash and lock the flash exposure to the required intensity to illuminate the subject.
- Each time you press the  button, the flash exposure locks at the required intensity for that composition.
- Using any button other than the omni selector cancels the FE lock.

4 Recompose the image and shoot.

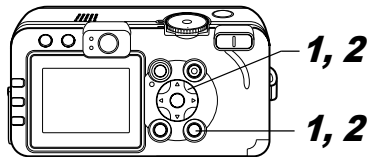
 The FE lock function is not available when [Flash Adjust] is set to [Manual].

Switching between Flash Adjustment Settings

Shooting Mode Dial

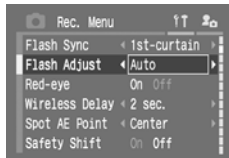
Tv Av

The flash fires with automatic flash adjustments (except in the **M** mode), but it is possible to set it so that it fires without any adjustments ([Flash Output] can be set).



1 Select [Flash Adjust] from the (Rec.) menu.

- See *Selecting Menus and Settings* (p. 64).



2 Select [Auto] or [Manual] using the ◀ or ▶ arrow and press the MENU button.

Setting the Flash Adjustment/Flash Output

Shooting Mode Dial

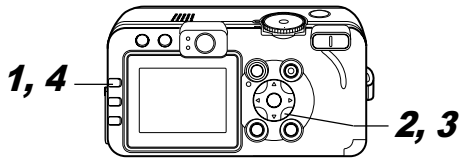
P Tv Av M

Flash Adjust

- When [Flash Adjust] is set to [Auto], settings can be adjusted in 1/3-stop increments in the range of -2 stops to +2 stops.
- You can enjoy flash photography with exposure adjustments with the combined use of the camera's exposure compensation function.

Flash Output

- In M mode or when [Flash Adjust] is set to [Manual], the flash output can be controlled in three steps, starting from FULL, when shooting.



1 Press the FUNC. button.

2 Select (+/- (Flash) or Flash Output) using the ▲ or ▼ arrow.

3 Adjust the compensation using the ◀ or ▶ arrow.

- You can shoot the image right after selecting settings by pressing the shutter button. The menu displays again after the shot, allowing you to change the settings easily.



e.g. [Flash Adjust] set to [Auto]



e.g. [Flash Adjust] set to [Manual]

4 Press the FUNC. button.

Switching the Timing at which the Flash Fires

Shooting Mode Dial

P Tv Av M

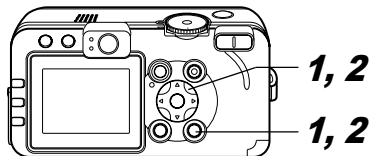
1st-curtain	The flash fires right after the shutter opens, regardless of the shutter speed. Usually, the 1st-curtain is used when shooting.
2nd-curtain	The flash fires right before the shutter closes, regardless of the shutter speed. Compared with the 1st-curtain, the flash fires later and this allows you to shoot images in which, for example, a car's rear lamps seem to trail off behind.




Image shot with the 1st-curtain setting

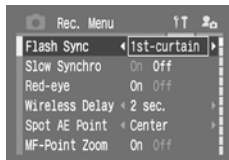


Image shot with the 2nd-curtain setting



1 From the **[ (Rec.)]** menu, select **[Flash Sync]**.

- See *Selecting Menus and Settings* (p. 64).



2 Select **[1st-curtain]** or **[2nd-curtain]** using the **◀** or **▶** and press the **MENU** button.

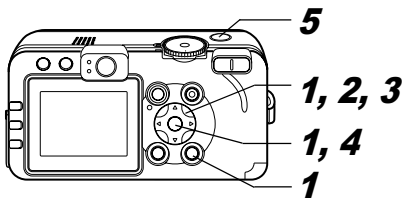
Shooting Images at Set Intervals (Intervalometer)

Shooting Mode Dial

P Tv Av M

You can shoot images at a set interval. This function can be used for fixed-point observation of plants and blooming flowers. The shooting interval time can be set from 1 to 60 minutes and 2 to 100 images can be shot.

Since the camera may shoot continuously for an extended period of time, the use of the AC Adapter Kit ACK700 (sold separately) is recommended (p. 147).



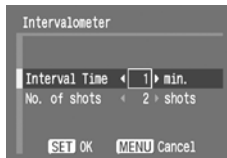
1 Select [Intervalometer] from the [Rec.] menu and press the **SET** button.

• See *Selecting Menus and Settings* (p. 64).



2 Select an interval time using the **◀** or **▶** arrow.

• If you press the **◀** or **▶** arrow continuously, the interval time changes in units of 5 minutes at a time.



3 Press the **▼** arrow and select the number of shots using the **◀** or **▶** arrow.

- If you press the **◀** or **▶** arrow continuously, the number of shots changes in units of 5 shots at a time.
- The maximum number of shots* is determined according to the CF card's remaining capacity.

* The maximum number of shots may decrease according to the images shot.

4 Press the SET button.

- The camera exits the menu screen and **Int.** appears at the lower right of the LCD monitor.

5 Press the shutter button.

- The first image is shot and the interval shooting session starts.
- Once the set number of shots is taken the camera automatically powers down regardless of the power saving function settings.
- If the below operations are accessed while the interval shooting is in process, the interval shooting session will be canceled.
 - Turning the shooting mode dial while the camera is waiting to shoot the next image
 - Pressing the shutter button halfway while the camera is waiting to shoot the next image
 - Opening the CF card slot / battery cover
 - Switching to Playback mode
 - Turning off the power



- Once the interval shooting session is started, all operation buttons become inactive.
- The lens stays extended until the next image is shot.
- Images are not displayed on the LCD monitor right after being shot.
- Interval shooting is not available when the date and time are not set.
- Continuous shooting is not available.
- AEB mode and the Focus-BKT mode settings cannot be set.

Shooting Problem Subjects for the Autofocus

The autofocus may not work well on the following types of subjects.

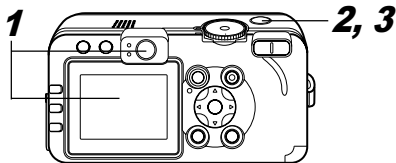
- Subjects with extremely low contrast to the surroundings
- Subjects mixing close and far objects
- Subjects with extremely bright objects at the center of the composition
- Subjects that are moving quickly
- When shooting through glass, get as close as possible to avoid reflection off the glass.
- Subjects with horizontal stripes

To shoot these subjects, first aim the camera at an object at a similar distance, lock the focus and recompose the image with the desired subject, or use manual focus or AF lock.

Shooting with Focus Lock

Shooting Mode Dial

AUTO      P Tv Av M



1 Aim the AF frame at an object at a similar distance to the subject you wish to shoot.

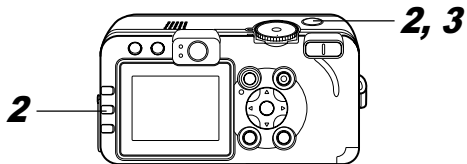
2 Press the shutter button halfway to lock the focus.

- The AE setting will also lock when you do this. The exposure may occasionally be incorrect if the difference between the two items is too great. Use AF lock or AE lock when this happens.

3 Keep it pressed while you recompose the image and press the shutter button all the way to shoot the image.

Shooting in AF Lock Mode

Shooting Mode Dial




1 Aim the AF frame at an object at a similar distance to the subject you wish to shoot.

2 Press the shutter button halfway and while keeping it pressed, press the MF button.

- MF appears on the LCD monitor.
- The focus will stay locked even if you release the shutter button and MF button.

- Pressing the MF button a second time cancels the manual focus mode.

3 Recompose the image and press the shutter button all the way to shoot the image.

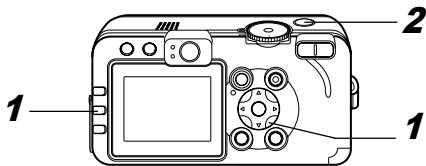
 AF lock is convenient because you can let go of the shutter button to recompose the image. In addition, since the focus stays locked to the same position even after the shot is taken, you can immediately shoot the next image with the same focus position.

Shooting in Manual Focus Mode

Shooting Mode Dial



The focus can be manually set.



1 Press and hold the MF button, then press the ▲ or ▼ arrow.

- The focus will lock and the MF icon and the MF indicator will appear on the LCD monitor.



MF Indicator

2 Press the shutter button all the way to shoot the image.

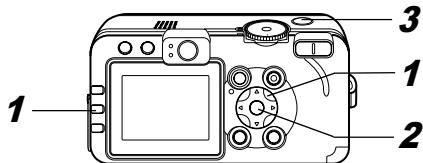
- When the [] (Rec.) menu's [MF-Point Zoom] is set to [On], if a particular AF frame has been manually selected (p. 76), the portion of the image in that frame will appear magnified.*¹
- * Except in the [], when the digital zoom is activated or a TV is used as the display.
- ¹ Can also be set so that the image displayed is not magnified (p. 67).
- The MF indicator shows approximate figures. Use them as a shooting guideline only.
- Adjust the focus using the ▲ or ▼ arrow until the image appears focused.
- Pressing the MF button a second time cancels the manual focus mode.

Using the Manual Focus in Combination with the Auto Focus

Shooting Mode Dial



The camera automatically searches for a more suitable focusing point from the current manually focused location.





1 Focus the camera with the manual focus.

2 Press the SET button.

- The camera focuses automatically to a more accurate focusing point near the current focusing point.

3 Press the shutter button all the way to shoot the image.

 You cannot change the AF frame setting while focusing manually. Cancel the manual focus mode, then change the AF frame setting.

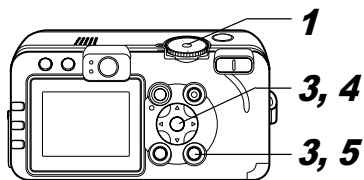
 You can change the MF indicator displayed distance units (p. 69).

C Saving Custom Settings

Shooting Mode Dial

P Tv Av M C

You can save frequently used shooting modes and various shooting settings to the **C** (Custom) mode. When necessary, you can then shoot images with previously saved settings by simply turning the shooting mode dial to **C**. Settings that are usually forgotten when the shooting mode is changed or when the power is turned off (such as Continuous Shooting and Self-timer mode) are also remembered.



1 Turn the shooting mode dial to **P**, **Tv**, **Av**, **M** or **C**.

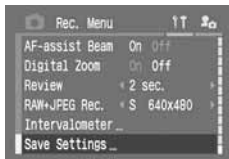
- When you wish to re-save partially modified settings (except shooting mode) that were previously saved in the **C** mode, select **C**.

2 Set the setting contents you wish to save.

Settings that can be saved to the **C** mode

- Shooting mode (**P**, **Tv**, **Av**, **M**)
- Items that can be set in **P**, **Tv**, **Av** and **M** modes (p. 170)
- Shooting menu settings
- Zoom location
- Manual focus location

3 Select [Save Settings] from the [RECALL] (Rec.) menu and press the SET button.



- See *Selecting Menus and Settings* (p. 64).

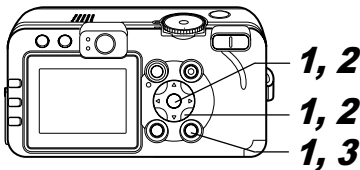
4 Select [OK] and press the SET button.

5 Press the MENU button.



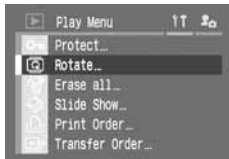
- ♦ The setting contents do not influence other shooting modes.
- ♦ Saved settings can be reset (p. 71).

Images can be rotated 90° and 270° clockwise on the LCD monitor.



1 Select [Rotate] from the [Play] (Play) menu and press the SET button.

- See *Selecting Menus and Settings* (p. 64).



2 Select an image you want to rotate using the ◀ or ▶ arrow and press the SET button.



- The image cycles to the next orientation (90° → 270° → original) each time the **SET** button is pressed.

3 Press the MENU button.

- The Play menu appears again. Press the **MENU** button again to close the menu.



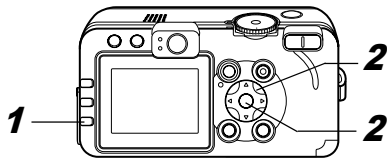
- Movies cannot be rotated.
- When images are downloaded to a computer, the orientation of images rotated by the camera will depend upon the software used to download the images.



- ◆ Images can be magnified when rotated (p. 43).
- ◆ Images taken vertically with the auto rotate function (p. 111) set to [On] will automatically be rotated to the vertical position when viewed on the LCD monitor.

Attaching Sound Memos to Images

In Playback mode (including single image playback, index playback, magnified playback and the review immediately after shooting in Shooting mode) you can attach sound memos (up to 60 seconds) to an image. The sound data is saved in WAVE format.



1 Press the button while playing back images.

- The Sound Memo panel appears.

2 Select using the or arrow and press the SET button.

- The recording starts and the elapsed time







Sound Memo Panel


is displayed. Speak towards the microphone of the camera.

- To stop recording, press the **SET** button. To restart recording, press the **SET** button again.
- You can add as many sound memos as you like until their total time reaches 60 seconds.


Playing back the Sound Memos

- Select . Images with sound memos are displayed with the  mark (they do not display in No Information display mode). To stop playback, press the **SET** button. To restart playback, press the **SET** button again. You can adjust the volume using the  or  arrow.


Erasing the Sound Memos

- Check that  is displayed and select .

Exiting the Sound Memos Menu

- Press the  button.

- You cannot attach sound memos to movies.
- You cannot record or playback sound notes for images that already have an incompatible sound file attached. If you attempt to record or play such images, the "Incompatible WAVE format" message will display. Incompatible sound files can be deleted with this camera.
- Sound memos for protected images cannot be erased (p. 108).

 The volume can be adjusted in the Set up menu (p. 68). If you set [Mute] to [On] in the Set up menu, no sound is reproduced, however, you can resume the sound and adjust the volume by pressing the ▲ or ▼ arrow.

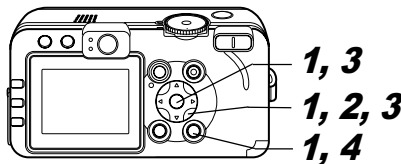
Automated Playback (Slide Show)


Slide show image settings are based on DPOF standards (p. 126).

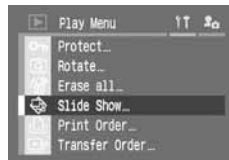
Starting a Slide Show

All images, or a selection of images, can be displayed one-by-one in an automated slide show.

All Images	Plays all the images on the CF card in order
Slide Show 1 - 3	Plays the images selected for each show in order (p. 105)

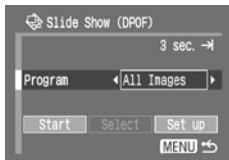


1 In the [ (Play)] menu, select [Slide Show] and press the SET button.



- See *Selecting Menus and Settings* (p. 64).

- 2** Select [Program] using the ▲ or ▼ arrow and select between [All images] or one of [Show 1]-[Show 3] using the ◀ or ▶ arrow.



- 3** Select [Start] using the ▲ or ▼ arrow and press the SET button.

The show will start and automatically stop when the show is done.

Pausing and Resuming a Slide Show

- Press the **SET** button to pause the show. Press it again to resume.

Fast Forward/Rewinding a Slide Show

- Use the ◀ or ▶ arrow to move to the previous or next image.

Stopping a Slide Show

- Press the **MENU** button during a slide show to stop it and display the slide show menu.

- 4** When the slide show is over, press the **MENU** button.

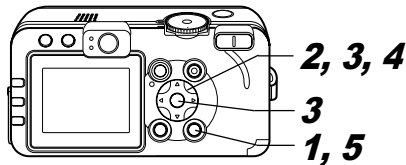
The slide show menu appears again. Press the **MENU** button again to close the menu.



- ◆ Movie images play for the length of time that they were recorded regardless of the time set in the slide show settings.
- ◆ The power saving function is disabled while a slide show plays on the camera (p. 109).

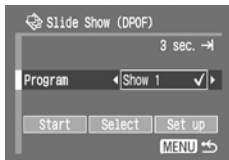
Selecting Images for Slide Shows

You can mark images for inclusion in slide shows 1-3. Up to 998 images may be marked per slide show. Images display in the order of their selection.



1 Display the slide show menu (p. 104).

2 Select [Program] using the ▲ or ▼ arrow and select [Show 1], [Show 2] or [Show 3] using the ◀ or ▶ arrow.



- A checkmark (✓) will appear beside a show already containing images.

3 Choose [Select] using the ▲, ▼, ◀ or ▶ arrow and press the SET button.

4 Mark images to include in the show.

Single Image Playback

- Move between images using the ◀ or ▶ arrow and mark or remove marks from images using the ▲ or ▼ arrow.



- The selection number and a check mark (✓) appear at the bottom of selected images.

Index Playback

- Press the zoom button's 🔍 to switch to index playback (3 images).
- Select an image using the ◀ or ▶ arrow and mark or remove marks from images using the ▲ or ▼ arrow.
- The selection number and a check mark (✓) appear at the bottom of selected images.
- After you press the SET button, you can select all the images by selecting [Mark all] using the ▲ or ▼ arrow and pressing the SET button again. You can deselect all the images by selecting [Clear all].
- You can select images using the ◀ or ▶ arrow and change the settings using the ▲ or ▼ arrow after [Mark all] or [Clear all] has been selected.

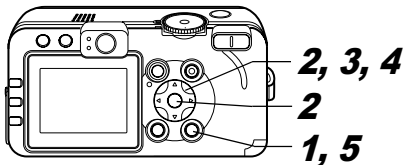


5 Press the MENU button.

- The image selection screen will close.

Adjusting the Play Time and Repeat Settings

Play Time	Sets the duration that each image in a slide show is displayed. The options are any one of 3-10 seconds, 15 seconds, 30 seconds and Manual.
Repeat	Sets whether the slide show stops when all the slides have been displayed or continues to display until stopped.



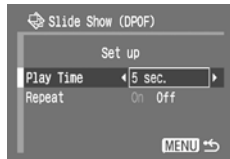
1 Display the slide show menu (p. 104).

2 Select [Set up] using the ◀ or ▶ arrow and press the SET button.



3 Select [Play Time] or [Repeat] using the ▲ or ▼ arrow.

4 Select a setting using the ◀ or ▶ arrow.



Play time

- Select a play time.

Repeat

- Select [On] or [Off].

5 Press the MENU button.

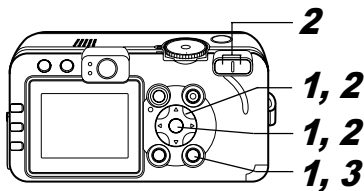
The set up menu closes.




- ◆ The display interval may vary somewhat for some images.
- ◆ Slide shows can be easily edited on a computer with the supplied software (*ZoomBrowser EX* or *ImageBrowser*).

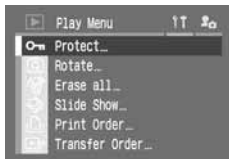
Protecting Images

You can protect important images from accidental erasure.




1 In the [ (Play)] menu, select [Protect] and press the SET button.

- See *Selecting Menus and Settings* (p. 64).




2 Select an image you want to protect using the ◀ or ▶ arrow and press the SET button.



- The  icon appears on protected images.
- To remove the protection, press the SET button again (in protection mode).
- You can make the selection of images easier by toggling between single image playback and index playback with the zoom button.

3 Press the MENU button.

The protect window closes.

 Please note that formatting (initializing) a CF card erases all data, including protected images (p. 19) and other file types. Please check the contents of a CF card before formatting it.

This camera is equipped with a power saving function. Depending on the power saving (p. 69), the camera may power down or the LCD monitor may go off automatically.

● Auto Power Down

[On]:

● Shooting mode

Powers down approximately 3 minutes after the last time a camera control is accessed. The LCD monitor automatically shuts off approximately 1 minute*¹ after the last time a camera control is accessed even if [Auto Power Down] is set to [Off]. Press any of the camera's button to turn the LCD monitor back on.

*¹ This time can be changed.

● Playback mode

Powers down approximately 5 minutes after the last time a control is accessed on the camera.

● Printer Connection mode

Powers down approximately 5 minutes after the last time a control is accessed on the camera or something is printed on the printer.

[Off]: The power saving function does not activate.

● Display Off (Shooting Mode Only)

The LCD monitor shuts off after a specified period of time elapses and no camera control is accessed.


The following time settings can be selected: 10 sec./20 sec./30 sec./1 min.*²/2 min./3 min.

*² Default setting

When the Auto Power Down Function Activates

Turn the power on again.

Shooting mode: Close the lens cover, then open it again.

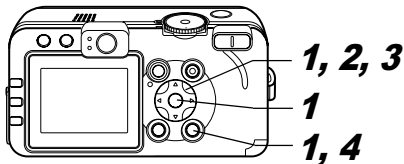
Playback/Printer Connection mode: Press the  (Playback) button.

When the Display Off Function Activates

The LCD monitor will be displayed if any of the camera's buttons are pressed.

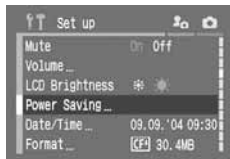


- ◆ Please note that the camera continues to consume a minimal amount of power even when the power saving function shuts it down.
- ◆ The power saving function is disabled while a slide show plays on the camera or during a computer connection (p. 104, 117).

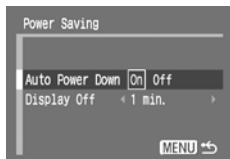


1 Select [Power Saving] in the [T] (Set up) menu and press the SET button.

- See *Selecting Menus and Settings* (p. 64).



2 Select [Auto Power Down] using the ▲ or ▼ arrow and select [On] or [Off] using the ◀ or ▶ arrow.



3 Select [Display Off] using the ▲ or ▼ arrow and select a time using the ◀ or ▶ arrow.

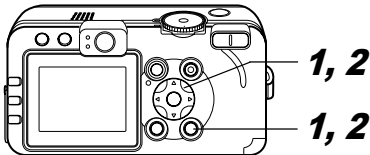
4 Press the MENU button.

Setting the Auto Rotate Function

Shooting Mode Dial

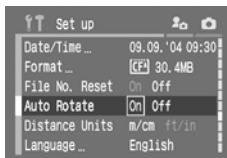
AUTO       P Tv Av M

This camera is equipped with an Intelligent Orientation sensor that detects the orientation of an image shot with the camera on end and automatically rotates it to the correct viewing orientation in the display. You can turn this function on/off.




1 Select [Auto Rotate] in the [Set up] menu.


- See *Selecting Menus and Settings* (p. 64).




2 Select [On] using the ◀ or ▶ arrow and press the MENU button.


- When this function is On, an icon showing the orientation of the camera appears at the upper right corner of the LCD monitor if it is set to Information View.

 : Normal

 : Camera on right end

 : Camera on left end



- This function may not operate correctly when the camera is pointed straight up or down. Check that the correct camera orientation icon (e.g. ) is displayed and if it is not, then set the Auto Rotate function to Off.
- Even if the Auto Rotate function is set to On, the orientation of images downloaded to a computer will depend upon the software used to download the images.

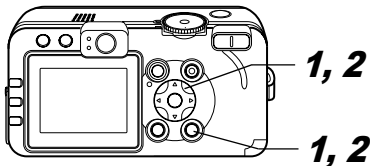


- ◆ When the camera is held on end to shoot, the Intelligent Orientation sensor judges the upper end to be "up" and the lower end to be "down". It then regulates the optimal white balance and exposure for vertical photography. This function operates regardless of the On/Off status of the Auto Rotate function.
- ◆ When changing the camera's orientation between the horizontal and vertical positions, you may hear noise coming from the orientation detection mechanism. This is not a malfunction.

Resetting the File Numbers

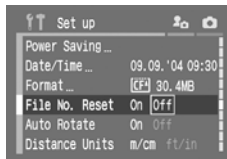
You can select the way file numbers are assigned.

On	The file numbers are reset to the start (100-0001) each time a new CF card is inserted. New images recorded on CF cards with existing files are assigned the next available number.
Off	The file number of the last image to be shot is memorized so that images recorded to a new CF card start from the next number.



1 In the [**1**] (Set up) menu, select [File No. Reset].

- See *Selecting Menus and Settings* (p. 64).



2 Select [On] using the ◀ or ▶ arrow and press the MENU button.

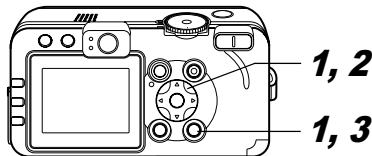


- ◆ Setting the [File No. Reset] to [Off] is useful for avoiding file name duplication when images are downloaded to a computer.
- ◆ See *Managing Image Files* (p. 160).

Customizing the Camera (My Camera Settings)

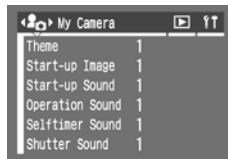
My Camera allows you to customize the start-up image and sound, operation, self-timer and shutter sounds. Each menu item has three choices.

Changing My Camera Settings



1 Press the MENU button and press the ▶ arrow twice.

The [My Camera] menu appears.



2 Select a menu item using the ▲ or ▼ arrow, then select setting content using the ◀ or ▶ arrow.

 : Off

 : General

 : Science fiction theme

 : Animal theme


- The contents of the  and  options can be changed (p. 70).

3 Press the MENU button.



The menu closes and settings are activated.

- In Shooting mode, the menu can be closed by pressing the shutter button halfway.



- ♦ If you select [Theme] in Step 2, you can select a consistent theme for each of the My Camera settings.
- ♦ If [Mute] in the [ (Set up)] menu is set to [On], no sound is reproduced except for the error warning signal regardless of the selected My Camera settings (p. 70). The Start-up image displays.

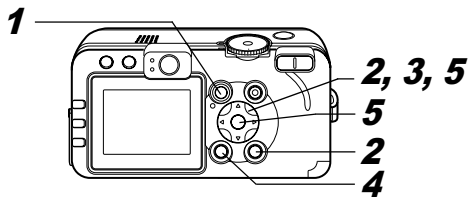
Registering My Camera Settings

This function registers new contents to the  and  options.

Images recorded onto the CF card and newly recorded sounds can be added to the camera. You can also use the supplied software to upload your computer's images and sounds to the camera. The following menu items can be saved to the camera.

- Start-up Image
- Start-up Sound
- Operation Sound
- Selftimer Sound
- Shutter Sound

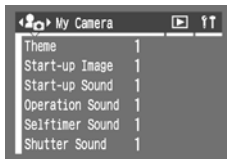
The CF card images and sounds can be registered to the camera with the following procedures.



1 Press the button to switch to the Playback mode (p. 22).

2 Press the MENU button and press the arrow twice.

The [] (My Camera) menu appears.



3 Select the menu item you wish to register using the or arrow and select or using the or arrow.

appears.

4 Press the DISPLAY button.

The start-up image screen or the sound recording menu appears

Registering a Start-up Image

- Select the image you wish to register using the or arrow and press the SET button.



Registering Start-up, Operation, Self-timer and Shutter Sounds

- Select (Record) using the or arrow and press the SET button.
- Recording will start and automatically stop when the time is exceeded.



Start-up Sound: 1 sec.

Operation Sound: 0.3 sec.

Self-timer Sound: 2 sec.

Shutter Sound: 0.3 sec.

- Select (Register) and press the SET button.

5 Select [OK] using the or arrow and press the SET button.



- The following cannot be registered as My Camera settings.
 - RAW images
 - Movies
 - Sound recorded using the Sound Memo function (p. 103)
- When you register new My Camera settings, the previously registered settings are erased.

File Format of My Camera Settings

My Camera settings should conform to the below file formats. However, CF card images shot with this camera can be registered as My Camera settings regardless of the below formats (**except RAW images, movies and sounds recorded using the Sound Memo function**).

● Start-up Image

- Recording image format JPEG (Base line JPEG)
- Sampling rate 4:2:0 or 4:2:2
- Image size 320 x 240 pixels
- File size 20 KB or less

● Start-up Sound, Operation Sound, Selftimer Sound and Shutter Sound

- Recording format WAVE (monaural)
- Quantization bit 8 bit

- Sampling frequency 11.025 kHz and 8.000 kHz
- Recording time

	11.025 kHz	8.000 kHz
Start-up Sound	1.0 sec. or less	1.3 sec. or less
Operation Sound	0.3 sec. or less	0.4 sec. or less
Selftimer Sound	2.0 sec. or less	2.0 sec. or less
Shutter Sound	0.3 sec. or less	0.4 sec. or less

Any file format other than those described above cannot be used with this camera.

An example of this function is to record "Say cheese" as a self-timer sound so the camera will play back this sound 2 seconds before the photo is taken. You could also record cheerful music to bring out the natural smiles of your subjects, or so they can strike a pose fitting the music. In these ways, you can customize your camera by creating and adding new My Camera settings.

See the supplied *Software Starter Guide* for more information on creating and adding My Camera files.

The following methods can be used to download images recorded by the camera to a computer. Some methods are not applicable to all operating systems.

● Downloading via a Camera to Computer Connection

Windows 98 | Windows Me | Windows 2000 | Windows XP | Mac OS 9 | Mac OS X

- With this method, you download images using computer commands after you have installed the appropriate software.
→ See *Connecting the Camera to a Computer* (p. 117) on the right and the separate *Software Starter Guide*.

Windows 98 | Windows Me | Windows 2000 | Windows XP

- With this method, you download images using camera button operations after you have installed the appropriate software (the computer settings only need to be adjusted for the first download).
→ See *Connecting the Camera to a Computer* (p. 117) on the right and *Downloading Images by Direct Transfer* (p. 121).

Windows XP | Mac OS X

- With this method, you download images using computer commands without installing any software.
→ See *Connecting the Camera to a Computer* (p. 117) (software installation is not required) and *Connecting the Camera to the Computer to Download Images without Installing the Software* (p. 123).

● Downloading Directly from a CF Card

- With this method, you download images using a card adapter or card reader.
→ See *Downloading Directly from a CF Card* (p. 123).

Connecting the Camera to a Computer

Computer System Requirements

● Windows

OS	Windows 98 (Including Second Edition) Windows Me Windows 2000 Windows XP (Home Edition, Professional)
Computer Model	The above OS should be pre-installed on computers with built-in USB ports.

CPU	Windows 98/Windows Me/Windows 2000: Pentium 150 MHz or higher processor Windows XP: Pentium 300 MHz or higher processor For all of the above OS: Pentium 500 MHz or higher processor is recommended (for editing movies)
RAM	Windows 98/Windows Me/Windows 2000: 64 MB or more Windows XP: 128 MB or more For all of the above OS: 128 MB or more is recommended (for editing movies)
Interface	USB
Free Hard Disk Space	<ul style="list-style-type: none"> ● Canon Utilities ZoomBrowser EX: 200 MB or more (Including the PhotoRecord printing program) PhotoStitch: 40 MB or more ● Canon Camera TWAIN Driver: 25 MB or more ● Canon Camera WIA Driver: 25 MB or more
Display	800 x 600 pixels/High Color (16 bit) or better is required 1,024 x 768 pixels or better is recommended

● Macintosh

OS	Mac OS 9.0 - 9.2, Mac OS X (v10.1/v10.2/v10.3)
Computer Model	The above OS should be preinstalled on computers with built-in USB ports.
CPU	PowerPC
RAM	Mac OS 9.0 - 9.2: 64 MB or more of application memory Mac OS X (v10.1/v10.2/v10.3): 128 MB or more

Interface	USB
Free Hard Disk Space	<ul style="list-style-type: none"> ● Canon Utilities ImageBrowser: 120 MB or more PhotoStitch: 30 MB or more
Display	800 x 600 pixels/32,000 colors or better is required 1,024 x 768 pixels or better is recommended

You must install the software and driver bundled on the supplied Canon Digital Camera Solution Disk onto your computer before connecting the camera to a computer.



The camera will not operate correctly if you connect it to your computer before installing the driver and software. If this happens, please refer to the *Troubleshooting* section of the *Software Starter Guide*.



- ◆ You do not need to turn off the camera or computer power when making a USB connection.
- ◆ Please refer to your computer's manual for information regarding the location of the USB port.
- ◆ You are recommended to use fully charged battery pack or AC Adapter Kit ACK700 (sold

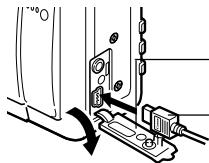
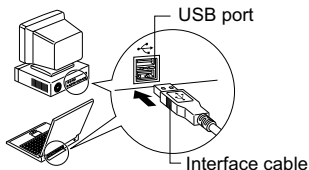
separately) to power the camera when connecting to a computer (p. 14, p. 147).

- ◆ All procedures performed with a connection to a USB 2.0 compliant board are not guaranteed.

1 Install the driver and the software applications bundled on the Canon Digital Camera Solution Disk.

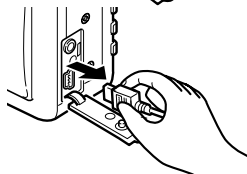
- Please see the *Software Starter Guide* for the installation procedures.

2 Use the supplied interface cable to connect the computer's USB port to the camera's DIGITAL terminal.



DIGITAL Terminal

1. Open the terminal cover with your finger nail.
2. Insert the connector until it clicks.



Always grasp the connector to remove the USB cable from the camera's **DIGITAL** terminal.

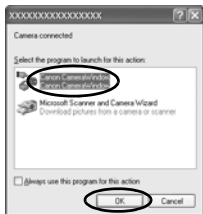
Windows

→ Proceed to steps **3** and **4** below.

Macintosh

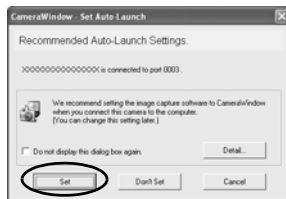
→ Refer to the *Software Starter Guide* and download images.

- 3** Select [Canon CameraWindow] in the events dialog that appears on the computer and click [OK] (first time only).



- !** If the events dialog fails to appear, click the [Start] menu, followed by [Programs] or [All Programs], [Canon Utilities], [CameraWindow] and [CameraWindow Set Auto-Launch].


- 4** Click [Set] in the [CameraWindow-Set Auto-Launch] window (first time only).



1 Confirm that the Direct Transfer menu is displayed on the camera's LCD monitor.

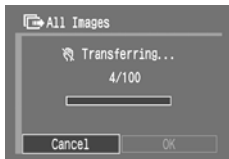


Direct Transfer Menu

- The  button will light blue.
- Press the **MENU** button if the Direct Transfer menu fails to appear.

All Images/New Images/DPOF Trans. Images

2 Use or to select , or and press the button.




- To cancel the transfer, press the **SET** button.
- The images will download and the Direct Transfer menu will reappear.

Select & Transfer/Wallpaper

2 Use or to select or and press the button (or **SET** button).

3 Use or to select images to download and press the button (or **SET** button).



- The images will download.
- The  button will blink blue while downloading is in progress.


4 Press the **MENU** button.

- The Direct Transfer menu will display again.



Only JPEG format images can be downloaded as wallpaper for the computer. After images are transferred, they are automatically converted to BMP format.



The option selected with the  button is retained even when the camera's power is shut off. The previous setting will be in effect the next time the Direct Transfer menu is displayed. The image selection screen will appear directly when the Select and Transfer or the Wallpaper option was last selected.

Connecting the Camera to the Computer to Download Images without Installing the Software

If you are using Windows XP or Mac OS X (v10.1/v10.2/v10.3), you can use the software distributed with these operating systems to download images (JPEG format only) without installing the software bundled on the Canon Digital Camera Solution Disk. This is useful for downloading images to a computer in which the software is not installed. However, please note that there are certain limitations to downloading images with this method. For more details, please refer to the *For Windows® XP and Mac OS X Users* leaflet.

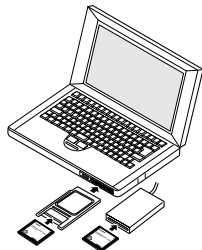
1 Use the supplied interface cable to connect the computer's USB port to

the camera's DIGITAL terminal. (See steps **2** on p. 119.)

2 Follow the onscreen instructions to proceed with downloading.

Downloading Directly from a CF card

1 Eject the CF card from the camera and insert it into a CF card reader connected to the computer.



- If you are using a PC card reader or a PC card slot, first insert the CF card into a PC card adapter (sold separately) and then insert the loaded adapter into the slot.

Viewing Images on a TV Set

- Refer to your card adapter's or card reader's manual for information regarding the connection between the computer and card adapter or card reader.

2 Double-click the icon of the drive with the CF card.

- Depending on the operating system, a window opens automatically.

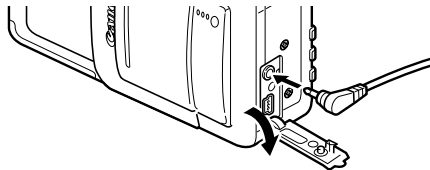
3 Copy images from the card into a folder of your choice on the hard disk.

- The images are stored in the [xxx CANON] folders located in the [DCIM] folder (where xxx is a three-digit number from 100 to 998 (p. 160)).

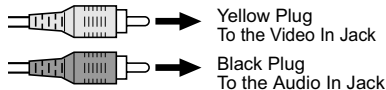
A video-compatible television connected via the supplied AV cable AVC-DC300 can be used to view images as you shoot or play back them.

1 Turn off the camera (p. 21) and the TV.

2 Attach the AV cable to the A/V OUT terminal on the camera.



3 Plug the other ends of the AV cable to the video in and audio in jacks on the TV.



4 Turn on the TV and switch it to Video mode.

5 Power the camera into Shooting mode or Playback mode (p. 21).

- The image will appear on the TV. Shoot or play back images as usual.




- ◆ No image will appear on the LCD monitor when the camera is connected to a TV monitor.
- ◆ The video output signal can be switched (NTSC or PAL) to accommodate different regional standards. The default setting will vary between regions.

NTSC: Japan, U.S.A., Canada, Taiwan, etc.


PAL: Europe, Asia (excluding Taiwan),
Oceania, etc.

If an incorrect video system is set, the output image will not display properly.

- ◆ If the TV is a stereo model, you can plug the audio plug into either the left or right Audio In jack. Please refer to the TV's manual for details.
- ◆ A TV set cannot be used in the  (Stitch Assist) mode.

About Printing

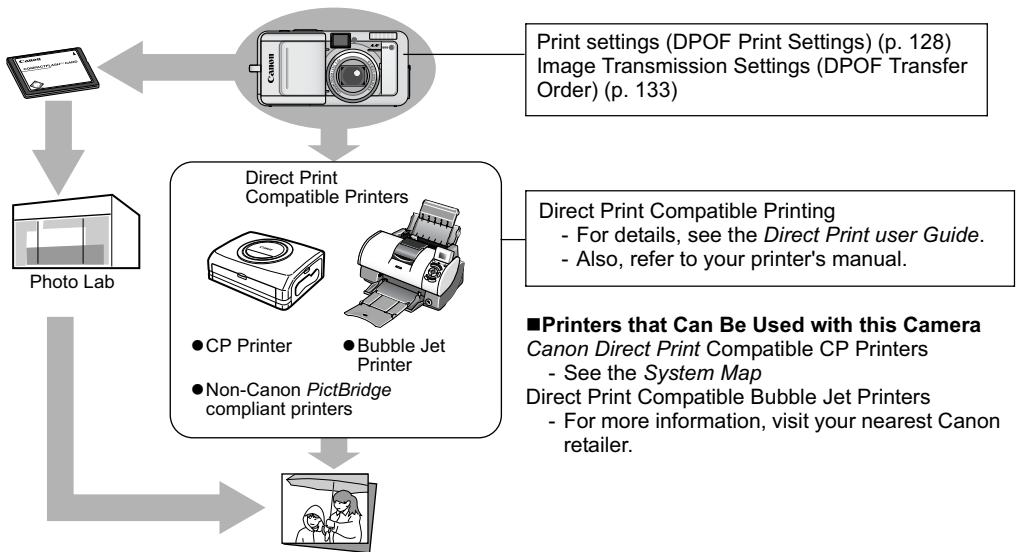
There are two ways of printing images shot with this camera.

- You can easily print images stored in the CF card by connecting the camera to a direct print compatible printer*¹ with a cable and then pressing the camera's  button.
- You can specify the images on your CF card you want to print and how many copies you want (DPOF*² Print Settings), and then take the CF card to a participating photo lab that supports DPOF to have them printed out later.

*¹This camera complies with the industry standard *PictBridge*, therefore, you can connect the camera to non-Canon *PictBridge* compliant printers and print images.


*²Digital Print Order Format

This manual explains the DPOF print settings. For information on how to print images, refer to the *Direct Print User Guide* supplied with the camera.
Also, refer to your printer's manual.

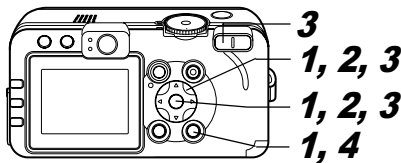



Print Settings (DPOF Print Settings)

You can select images on a CF card for printing and specify the number of print copies in advance using the camera. This is extremely convenient for sending the images to a photo developing service or for printing on a direct print function compatible printer. Refer to the *Direct Print User Guide* for instructions on how to select print settings from the printer.

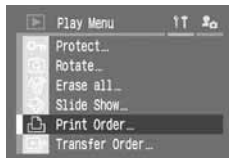
- The  mark may appear on images that have had print marks set by another DPOF compliant camera. These settings will be overwritten by any print marks set by your camera.
- The output of some digital printers or photo lab services may not reflect the specified print settings.
- Print settings cannot be set for movies.



Selecting Images for Printing

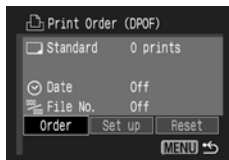


- 1** In the [] (Play) menu, select [Print Order] and press the SET button.

- See *Selecting Menus and Settings* (p. 64).



- 2** Select [Order] using the  or  arrow and press the SET button.



3 Select images for printing.

Single Images

- When the print type (p. 130) is set to [Standard] or [Both], select an image using the ◀ or ▶ arrow. You can set the number of copies (up to 99) to be printed using the ▲ or ▼ arrow.
- When the print type (p. 130) is set to [Index], select an image using the ◀ or ▶ arrow and mark or remove marks from images using the ▲ or ▼ arrow. A check mark appears on the marked image.
- You can use the same procedures to select images in index playback (3 images). Press the zoom button's 🔍 to switch between single image playback and index playback.



All the Images on the CF Card

- Press the zoom button's 🔍 to switch to index playback (3 images).
- You can set one copy of each image to print by pressing the **SET** button, then selecting [Mark all] using the ▲ or ▼ arrow, and pressing the **SET** button again.
- When the print type is set to [Standard] or [Both], the setting for the number of print copies can be changed for each image. When [Index] is selected, the print settings can be deleted. For the instructions on changing settings, please reread Step 3 from the beginning.
- You can cancel all the settings by selecting [Clear all].
- You can select images using the ◀ or ▶ arrow and change the settings using the ▲ or ▼ arrow after [Mark all] or [Clear all] has been selected.



Number of copies

4 Press the MENU button.





The selection mode will turn off and the Print Order menu will reappear.

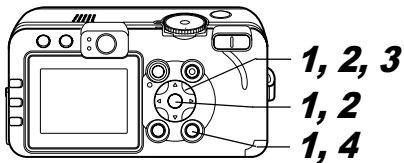


- ♦ Images are printed in order from oldest to newest by the shooting date.
- ♦ A maximum of 998 images can be marked per CF card.
- ♦ When [Print Type] is set to [Both], the number of copies can be set. When it is set to [Index], the number of copies cannot be set (only one copy will be printed).
- ♦ Print settings can also be assigned to images with the supplied software programs (ZoomBrowser EX or ImageBrowser) on a computer.

Setting the Print Style

The following print settings can be selected.

Print Type	 Standard	Prints one image per page
	 Index	Prints the selected images together at a reduced size in an index format
	  Both	Prints the images in both the standard and index formats
Date		Adds the date to the print
File No.		Adds the file number to the print



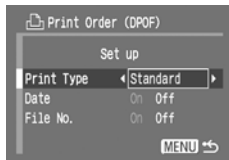
1 In the [] (Play) menu, select [Print Order] and press the SET button.

- See *Selecting Menus and Settings* (p. 64).

2 Select [Set up] using the ◀ or ▶ arrow and press the SET button.



3 Select [Print Type], [Date] or [File No.] using the ▲ or ▼ arrow and select settings using the ◀ or ▶ arrow.



Print Type

- Select [Standard], [Index] or [Both].

Date

- Select [On] or [Off].

File No.

- Select [On] or [Off].

4 Press the MENU button.

The set up menu will close and the Print Order menu will reappear.



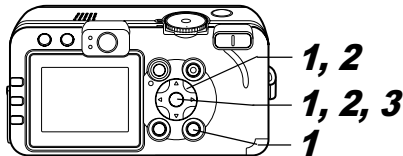
- When [Print Type] is set to [Index], the [Date] and [File No.] cannot be set to [On] at the same time.
- When connected to a CP printer, both [Date] and [File No.] can be set to [On] if [Print Type] is set to [Both] or [Standard], however, only the date is printed for the standard print and only the file number is printed for the index print.




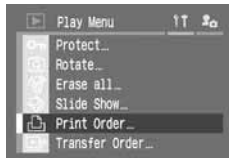
The date prints as the date and time in the format specified in the Set Date/Time menu (p. 24).

Resetting the Print Settings

The print settings can all be removed at once. The print type is reset to [Standard] and the date and file number options are set to [Off].

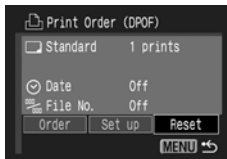


1 In the [ (Play)] menu, select [Print Order] and press the SET button.



- See *Selecting Menus and Settings* (p. 64).

2 Select [Reset] using the ◀ or ▶ arrow and press the SET button.



3 Select [OK] using the ◀ or ▶ arrow and press the SET button.

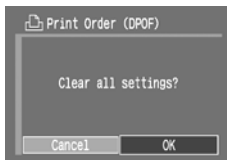




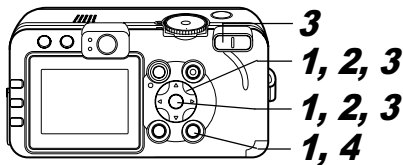
Image Transmission Settings (DPOF Transfer Order)

You can use the camera to specify settings for images before downloading to a computer. Refer to the *Software Starter Guide* for instructions on how to transfer images to your computer. You cannot use this function to transfer several images at once on Mac OS X computers.

The settings used on the camera comply with the Digital Print Order Format (DPOF) standards.

 The  mark may appear on images that have had transfer marks set by another DPOF compliant camera. These settings will be overwritten by any transfer marks set by your camera.

Selecting Images for Transferring

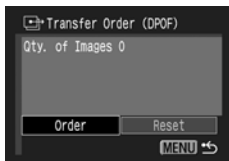


1 In the [▶] (Play) menu, select [Transfer Order] and press the SET button.

- See *Selecting Menus and Settings* (p. 64).



2 Select [Order] using the ◀ or ▶ arrow and press the SET button.



- To cancel the image transfer settings, select [Reset] instead.

3 Select images for transferring.

Single Images

- Select an image using the ◀ or ▶ arrow and mark or remove marks from images using the ▲ or ▼ arrow. A check mark (✓) appears on the marked image.
- You can use the same procedures to select images in index playback (3 images). Press the zoom button's 🔍 to switch between single image playback to index playback.



All the Images on a CF Card

- Press the zoom button's 🔍 to switch to index playback (3 images).
- Press the SET button and select [Mark all] using the ▲ or ▼ arrow,



then press the **SET** button again to select all the images.

- If you select [Clear all] instead of [Mark all], you can remove marks from all the images.
- You can select images using the ◀ or ▶ arrow and change the settings using the ▲ or ▼ arrow after [Mark all] or [Clear all] has been selected.

4 Press the MENU button.

The selection mode will turn off and the Transfer Order menu will reappear.



- ◆ Images are transferred in order from oldest to newest by the shooting date.
- ◆ A maximum of 998 images can be marked per CF card.

The following messages may appear on the LCD monitor.

- For messages which may appear when a printer is connected, refer to the *Direct Print User Guide*.



Busy...	Image is being recorded to, or read from, CF card. Resetting all the camera and menu settings to default
No memory card	You turned on the power without a CF card installed.
Cannot record!	You attempted to shoot an image without a CF card installed.
Memory card error!	CF card has experienced an anomaly.
Memory card full	CF card is too full to accommodate more images or print settings.
Naming error!	The file could not be created because there is a file with the same name as the directory that the camera is attempting to create, or the highest possible file number has already been reached. In the Set up menu, please set [File No. Reset] to [On]. After you save all the images you wish to retain onto a computer, format the CF card (p. 19). Please note that formatting will erase all the existing images and other data.
Change the battery pack.	Battery charge is insufficient to operate the camera. Replace it immediately with a charged battery pack or recharge it.
No image	No images recorded on CF card.
Image too large	You attempted to play back an image larger than 4064 x 3048 pixels.
Incompatible JPEG format	You attempted to play back an incompatible JPEG file.
Corrupted data	You attempted to play back an image with corrupted data.
RAW	You attempted to play back a RAW image in an incompatible format.
Cannot magnify!	You attempted to magnify a movie or an image that was photographed with another camera, recorded in a different format, or edited on a computer.



Cannot rotate	You attempted to rotate a movie or an image that was photographed with another camera, recorded in a different format, or edited on a computer.
Unidentified Image	You attempted to play back an image that was recorded in a special format (proprietary format used by the camera of another manufacturer, etc.) or a movie clip recorded by another camera.
Incompatible WAVE format	Cannot attach sound memos to the image because the image has some sound file recorded in an inappropriate format.
Protected!	You attempted to erase a protected image or movie.
Too many marks	Too many images have been marked with print settings, transfer settings or slide show settings. Cannot process any more.
Unselectable image	You attempted to set the print settings for a non-JPEG file.
Cannot complete!	Couldn't save the print, transfer or slide show settings.
Cannot register this image!	You attempted to register an image or movie recorded with another camera or shot in the RAW format as a start-up image.
Cannot change!	You attempted to change to the RAW format an image that was shot with the digital zoom or that was already recorded in the RAW format.

Troubleshooting

Problem	Cause	Solution
Camera will not operate	Power is not turned on.	Turn on the camera. → See <i>Turning the Power On/Off</i> (p. 21)
	CF card slot / battery cover opened.	Confirm that the CF card slot cover and battery cover are securely closed.
	Insufficient battery voltage.	● Fully charge the battery, then put it in the camera. ● Use the Compact Power Adapter.
	Poor contact between camera and battery terminals.	Wipe the terminals with a clean, dry cloth.
Camera will not record	Camera is in Playback or computer/printer connection mode.	● Switch to Shooting mode. ● See <i>Switching Between Shooting and Playback</i> (p. 22). ● During a computer or printer connection, disconnect the interface cable before switching the camera to Shooting mode.
	Flash is charging (Blinking ⚡ on LCD monitor).	Wait until ⚡ stops blinking and lights steadily, signaling that the flash is charged, then press the shutter button.
	CF card full.	● Insert a new CF card. ● If required, download the images to a computer and erase them from the CF card to make space.
	CF card not formatted correctly.	● Format CF card. → See <i>Formatting a CF Card</i> (p. 19). ● If reformatting doesn't work, the CF card logic circuits may be damaged. Contact the nearest Canon Customer Support Help Desk.

Problem	Cause	Solution
Cannot play back	You attempted to play back images shot with another camera or images edited on a computer.	Computer images that cannot be played back will play back if they are added to the camera using the bundled software program ZoomBrowser EX or ImageBrowser. See the <i>ZoomBrowser EX/ImageBrowser Software User Guide</i> (PDF).
	File name was changed with a computer or file location was changed.	Set the file name or location to the file format/structure of the camera. → See <i>About File and Folder Numbers</i> (p. 160)
Lens will not retract	CF card slot / battery cover opened with camera on.	Close the CF card slot / battery cover, then turn off the camera.
	CF card slot cover or battery cover opened while camera was recording to CF card (warning signal).	Close the CF card slot / battery cover, then turn off the camera.
	Switched to Playback mode from Shooting mode.	The lens does not retract in this case. To make the lens retract, close the lens cover.
Battery pack consumed quickly	Battery terminals are dirty.	Wipe them well with a dry cloth before use.
	Battery pack capacity reduced because of disuse for one year or more after being fully charged.	Replace the battery pack with a new one.
	The Battery have lost their effectiveness.	Replace the battery pack with a new one.
Battery pack does not charge	Poor electrical contact.	Insert the charger plug firmly into the power outlet.
	Battery terminals are dirty.	Wipe them well with a dry cloth before charging.
	Battery life exceeded.	Replace the battery pack with a new one.

Problem	Cause	Solution
Image is blurred or out of focus	Camera moved.	<ul style="list-style-type: none"> ● Be careful not to move the camera when pressing the shutter button. ● Use a tripod at slow shutter speeds when the camera shake warning  appears.
	Autofocus function hampered by obstruction to AF auxiliary light emitter.	Be careful not to block the AF auxiliary light emitter with your finger or other items.
	AF-assist Beam is set to off.	Set the AF-assist Beam to [On]. → See <i>Rec. Menu</i> (p. 67)
	Subject out of focal range.	<ul style="list-style-type: none"> ● Ensure that there is at least 44 cm (1.4 ft.) between the camera lens and subject. ● Use the  (Macro) mode to shoot close-ups between 4 and 44 cm (1.6 in. and 1.4 ft.) at maximum wide angle and 30 and 44 cm (1.0 ft. and 1.4 ft.) at maximum telephoto.
	Subject is hard to focus on.	Use the focus lock or the manual focus to shoot the image. → See <i>Shooting Problem Subjects for the Autofocus</i> (p. 96).
Subject in recorded image is too dark	Insufficient light for shooting.	Set the flash to on.
	Subject dark in comparison to the background.	<ul style="list-style-type: none"> ● Set the exposure compensation to a positive (+) setting. ● Use the AE lock or spot metering function. → See <i>Locking the Exposure Setting (AE Lock)</i> (p. 89) and <i>Switching between Light Metering Modes</i> (p. 78).
Subject in recorded image is too dark	Subject too far for flash to reach.	<ul style="list-style-type: none"> ● To use the flash, shoot within the following ranges: ISO 100 equivalent: 55 cm to 4.2 m (1.8 ft. to 14 ft.) from the subject at the maximum wide angle and within 55 cm to 2.0 m (1.8 ft. to 6.6 ft.) at the maximum telephoto setting. ● Raise the ISO sensitivity and then shoot. → See <i>Changing the ISO Speed</i> (p. 84).

Problem	Cause	Solution
Subject recorded in image is too bright	Subject too close causing flash to be too bright.	Adjust the flash output with the flash exposure compensation function (p. 92).
	Subject bright in comparison to the background.	<ul style="list-style-type: none"> ● Set the exposure compensation to a negative (-) setting. ● Use the AE lock or spot metering function. → See <i>Locking the Exposure Setting (AE Lock)</i>(p. 89) and <i>Switching between Light Metering Modes</i> (p. 78).
	Light shining directly on subject or reflected off subject into camera.	Change the shooting angle.
	Flash set to On.	Set the flash to Off.
A vertical bar of light (red, purple) appears on the LCD monitor/in the viewfinder	Subject too bright	This is a normal occurrence in devices containing CCDs and does not constitute a malfunction. (This red bar of light will not be recorded when shooting still photos, but it will be recorded when shooting movies.)
White dots or white asterisks appear on the image	Light from the flash has reflected off dust particles or insects in the air. This occurs more frequently in the following conditions: <ul style="list-style-type: none"> ● When shooting at the wide angle end. ● When shooting with a high aperture value in the aperture-priority AE mode. 	This is a phenomenon that occurs with digital cameras and does not constitute a malfunction.
Flash will not fire	Flash set to Off.	Set the flash to On.
Image not showing on TV	Incorrect video system setting.	Set the video system to the appropriate setting, NTSC or PAL, for your TV (p. 69).
	Shooting mode set to  (Stitch Assist).	The output will not appear on a TV monitor in  (Stitch Assist) mode. Shoot in a different mode.
Zoom does not operate.	Zoom button was moved while shooting in movie mode.	Operate the zoom before shooting in movie mode.

Problem	Cause	Solution
CF card image reading is slow	Currently used CF card has been formatted in a different device.	Use a CF card formatted with this camera. → See <i>Formatting a CF Card</i> (p. 19).
Recording images on the CF card takes too long		

Using the Wireless Controller (Sold Separately)

Installing the Battery

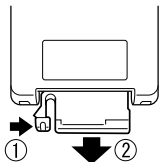
Install the date battery (CR2025) into the Wireless Controller WL-DC100 (sold separately) before use.



Warning

Be particularly careful to keep the date Battery out of the reach of children. Seek medical assistance immediately if a child swallows a battery since corrosive battery fluids could damage the stomach or intestinal wall.

1 Place your fingertip on ① and press it in the direction of the arrow while placing another fingertip on ② and removing the battery holder.

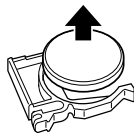


2 Place the date battery in the battery holder with the negative terminal (-) facing up. Then replace the battery holder into the wireless controller.



Removing the Battery

To remove the date battery, pull it in the direction of the arrow.

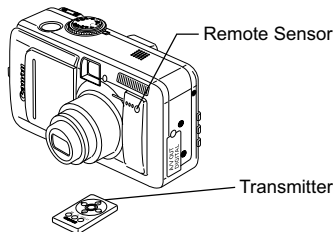


If you ever dispose of your camera, first remove the date battery for recycling according to the recycling system of your country.




Shooting/Playback

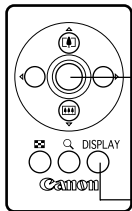
The wireless controller can be used to shoot or play back. The wireless controller can be operated from an approximate distance of up to 5 m (16.4 ft.) from the front remote sensor.



Shooting

Press the **FUNC.** button on the camera. Using the ▲ or ▼ arrows, select □* (drive mode). Using the ◀ or ▶ arrows, select  (remote control). Press the **FUNC.** button, then shoot the image.

* The current setting is displayed.

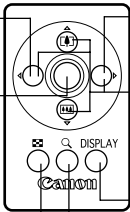


- Press the shutter button. The camera will shoot the image after the time set in [Wireless Delay] in the Rec. menu has elapsed (0 seconds, 2 seconds or 10 seconds).
- Each press of this button switches the information view mode between No Information and Information View.



The zoom cannot be operated.

Playback

- 
- Display the previous image
 - Display the next image
 - In magnified mode, these buttons move the magnified area around the image.
 - In index playback, these buttons move the image selection.
 - Each press of this button cycles the information view mode.
 - The display cycles between magnifications of approximately 2.5, 5 and 10.
 - Display images in sets of nine (index playback)



The operable range of the wireless controller will shorten under the following circumstances.

- When strong light strikes the camera.
- When the battery is weak.



The movie editing and printing functions are not available.

Using Conversion Lenses (Sold Separately)

The camera supports use of the separately sold Tele-converter TC-DC10. In order to attach any of these lenses, you also need to use the separately sold Conversion Lens Adapter LA-DC10.



Warning

- When attaching the tele-converter, be sure to screw it on securely. If they come loose, they may fall from the lens adapter, posing risk of injury from shattered glass.
- Never look into the sun or into strong light through the tele-converter as this can result in blindness or impairment of vision.



- If you use the built-in flash when shooting with the tele-converter, the outer area of the recorded image will come out relatively dark.
- When using the tele-converter, please set the focal length to the telephoto end. At other zoom settings, the image will appear as if its corners have been cut off.

Tele-converter
TC-DC10

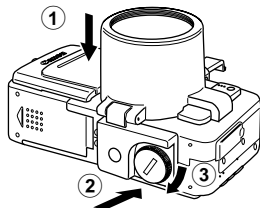
This 37 mm-threaded diameter magnifying conversion lens is for taking telephoto shots. The lens changes the focal length of the camera body's lens by a factor of 2.



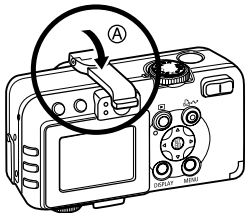
Filters cannot be attached to the tele-converter lens.

Attaching a Lens

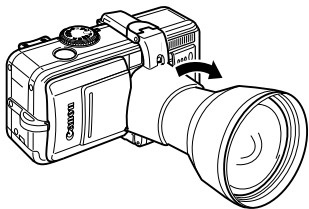
- 1** Open the lens cover to power up the camera.
- 2** Align the conversion lens adapter with the front of the camera, then attach the conversion lens adapter to the tripod screw hole.




- 3** Move **A** in the direction of the arrow and insert it into the viewfinder until it clicks into place.



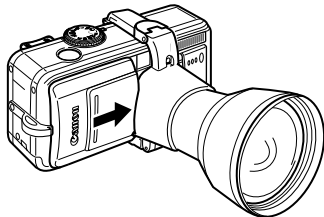
- 4** Turn the teleconverter in the direction of the arrow to attach it.



- When attached to the camera, do not carry the camera by the conversion lens adapter or the teleconverter. The camera could detach, fall and break.
- To protect the conversion lens, hold the conversion lens adapter with one hand and screw the conversion lens onto the adapter with the other hand.
- You should not shoot images in  (Stitch Assist) mode when using these attachments. Although it is possible to select this mode on the camera, the PhotoStitch software will not be able to stitch the images together at the computer.
- Completely remove all dust and dirt from conversion lenses with a lens blower brush before use. The camera may focus on any dirt that remains.
- Be careful when handling the lenses so as not to get fingerprints on them.



To turn off the power for a short time such as between shooting sessions, leave the conversion lens attached and lightly press the lens cover. If you will not be using the camera for a long time, remove the conversion lens and close the lens cover.



Using the Power Kits (Sold Separately)

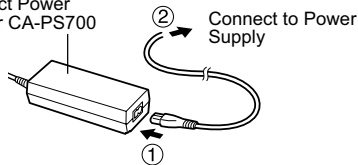
AC Adapter Kit

You are advised to use AC Adapter Kit ACK700* (optional) for long periods of use and when connecting to a computer or printer.

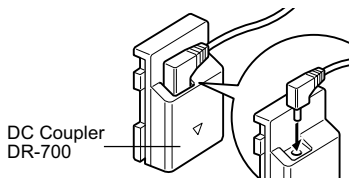
* Consists of Compact Power Adapter CA-PS700, DC Coupler DR-700 and a power cord.

- 1 Attach the power cord to the compact power adapter (1) and plug it into a power outlet (2).**

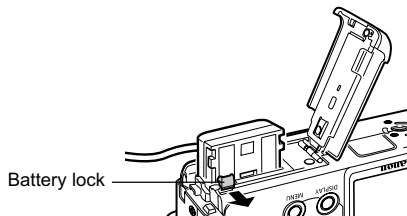
Compact Power Adapter CA-PS700



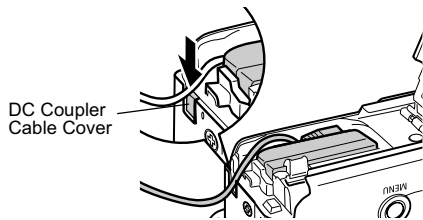
- 2** Connect the DC plug of the compact power adapter cable to the DC Coupler DR-700 terminal.



- 3** Open the CF card slot/battery cover, then insert the DC Coupler until it is locked.



- 4** Press and hold the DC Coupler cable cover using the cable, then close the CF card slot/battery cover.



- Always disconnect the power cord from the power supply after use.



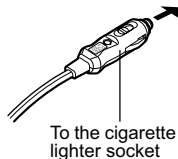
- Always turn the camera's power off before connecting or disconnecting the compact power adapter (p. 21).
- Use of any adapter other than AC Adapter Kit ACK700 may cause malfunction of the camera or AC adapter kit.

Using a Car Battery Charger (Sold Separately)

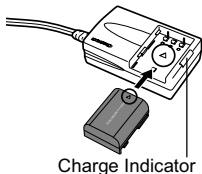
Car Battery Charger CBC-NB2 (sold separately) can be used to charge battery packs from an automobile's cigarette lighter socket.

Always ensure that the automobile's engine is running when you use the car battery charger. Use of it with the engine off may flatten the battery in some automobiles. Always unplug the car battery charger before turning off the engine.

1 With the engine running, plug the car battery cable into the cigarette lighter socket and the battery charger.



2 Insert the battery pack all the way into the battery charger as shown.



- Align the arrow on the battery pack and the arrow on the battery charger to correctly insert the battery pack in the charger.
- The charge indicator will light red while the battery pack is charging. It will change to green when the charge is complete.
- After charging, unplug the car battery cable from the cigarette lighter socket and remove the battery pack.



- The battery will stop charging whenever you turn the engine off, so be sure to unplug the car battery cable from the cigarette lighter socket.
- Wait until the engine is running again to plug the car battery cable into the cigarette lighter socket.
- The car battery charger can only be used in a negative ground car. It cannot be used in a positive ground car.

Camera Care and Maintenance

Use the following procedures to clean the camera body, lens, viewfinder, LCD monitor and other parts.

Camera body	: Wipe the body clean with a soft cloth or eyeglass lens wiper.
Lens	: First use a lens blower brush to remove dust and dirt, then remove any remaining dirt by wiping the lens lightly with a soft cloth. <ul style="list-style-type: none">● Never use synthetic cleansers on the camera body or lens. If dirt remains, contact the nearest Canon Customer Support Help Desk as listed on the separate Canon Customer Support leaflet.
Viewfinder LCD Monitor	: Use a lens blower brush to remove dust and dirt. If necessary, gently wipe the viewfinder and LCD monitor with a soft cloth or an eyeglass lens wiper to remove stubborn dirt. <ul style="list-style-type: none">● Never rub or press forcefully on the LCD monitor or viewfinder. These actions may damage them or lead to other problems.



Never use thinners, benzene, synthetic cleansers or water to clean the camera. These substances may distort or damage the equipment.

Specifications

All data is based on Canon's testing standard. Subject to change without notice.

PowerShot S60

Camera Effective Pixels	Approx. 5 million
Image Sensor	1/1.8-inch CCD (Total number of pixels: Approx. 5.3 million)
Lens	5.8 (W) – 20.7 (T) mm (35mm film equivalent: 28 - 100 mm) f/2.8 (W) – f/5.3 (T)
Digital Zoom	Approx. 4.1x (Up to approx. 15x in combination with the optical zoom)
Optical Viewfinder	Real-image zoom viewfinder Picture coverage approx. 80%
LCD Monitor	1.8-inch, low-temperature polycrystalline silicon TFT color LCD, approx. 118,000 pixels (Picture coverage 100%)
AF System	TTL autofocus Focus lock and Manual focus are available 9-point (AiAF)/1-point (AF) 1-point AF: Any position is available
Shooting Distance (from the front of the lens)	Normal AF: 44 cm (1.4 ft.) – infinity (W/T) Manual focus: 4 cm (1.6 in.) – infinity (W)/30 cm (1.0 ft.) – infinity (T)
Shutter	Mechanical shutter + electronic shutter
Shutter Speeds	15 – 1/2000 sec. 1.3 sec. or slower shutter speeds are available in Shutter-priority mode or Manual mode. Slow shutter speeds of 1.3 sec. or slower operate with noise reduction.
Light Metering System	Evaluative, Center-weighted average or Spot (Center or AF-point)
Exposure Control System	Program AE, Shutter-priority AE, Aperture-priority AE or Manual exposure control AE lock and Safety Shift are available.

Exposure Compensation	± 2.0 stops in 1/3-stop increments Auto exposure bracketing (AEB) is available.
Sensitivity	Auto, ISO 50/100/200/400 equivalent
White Balance	TTL auto, pre-set (available settings: Daylight, Cloudy, Tungsten, Fluorescent, Fluorescent H, Flash or Underwater) or custom
Built-in Flash	Auto*, on*, off * Red-eye reduction is available.
Flash Range	55 cm to 4.2 m (1.8 ft. to 14 ft.) (W), 55 cm to 2.0 m (1.8 ft. to 6.6 ft.) (T) (When sensitivity is set to ISO 100 equivalent.)
Flash Exposure Compensation	± 2.0 stops in 1/3-stop increments, FE lock, Slow synchro and 1st-curtain/2nd-curtain flash are available.
Shooting Modes	Auto Creative zone: Program, Shutter-speed priority, Aperture priority, Manual, Custom Image zone: Portrait, Landscape, Night scene, Fast shutter, Slow shutter, Stitch assist and Movie
Continuous Shooting	High-Speed continuous shooting: Approx. 2.0 shots/sec. Standard continuous shooting: Approx. 1.5 shots/sec. (Large/Fine mode with LCD monitor off)
Interval Shooting	Shooting interval: approx. 1 – 60 min. (1-min. increments) Number of shots: 2 – 100 shots (Maximum number of shots varies according to CF card capacity.)
Self-timer	Activates shutter after an approx. 10-sec./approx. 2-sec. delay
Wireless Control	Shooting and playback are available (wireless controller is sold separately). When shooting, image is captured instantly/approx. 2-sec./approx. 10-sec. after shutter button is pressed.
PC-controlled Shooting	Available (USB connection only. Exclusive software program is included in the camera kit.)
Recording Media	CompactFlash™ (CF) card (Type I and Type II)
File Format	Design rule for camera file system and DPOF compliant

Image Recording Format	Still images: JPEG (Exif 2.2)*1/RAW Movies: AVI (Image data: Motion JPEG; Audio data: WAVE (monaural))
Compression	Super fine, Fine, Normal
Number of Recording Pixels	Still images: Large: 2592 x 1944 pixels Medium 1: 2048 x 1536 pixels Medium 2: 1600 x 1200 pixels Small: 640 x 480 pixels Movies: 640 x 480 pixels (30 sec.)* 320 x 240 pixels (3 min.)* 160 x 120 pixels (3 min.)* * The data in parentheses refer to the maximum movie length per shooting.
Playback Modes	Single (histogram displayable), Index (9 thumbnail images), Magnified (approx. 10x (max.) in LCD monitor), Sound memos (recording/playback up to 60 sec.) or Slide show
Direct Print	<i>Canon Direct Print</i> and <i>Bubble Jet Direct</i> compatible, and <i>PictBridge</i> compliant
Display Languages	12 languages available for menus and messages (English, German, French, Dutch, Danish, Finnish, Italian, Norwegian, Swedish, Spanish, Chinese and Japanese)
My Camera Settings	The start-up image, start-up sound, shutter sound, operation sound and self-timer sound can be customized using the following methods: 1. Using the images and sounds recorded on a camera. 2. Using downloaded data from your computer using the supplied software.
Interface	USB (mini-B, PTP [Picture Transfer Protocol]) Audio/Video output (NTSC or PAL selectable, monaural audio)
Power Source	1. Rechargeable Lithium-ion battery (type: NB-2LH) (included in the camera kit) 2. AC Adapter Kit ACK 700 (sold separately) 3. Car Battery Charger Kit CBC-NB2 (sold separately)
Operating Temperature	0 – 40 °C (32 – 104 °F)
Operating Humidity	10 – 90 %

Dimensions	114.0 x 56.5 x 38.8 mm (4.5 x 2.2 x 1.5 in.) (excluding protrusions)
Weight	Approx. 230 g (8.1 oz.) (camera body only)

(W): Wide angle end
(T): Telephoto

*1 This digital camera supports Exif 2.2 (also called "Exif Print"). Exif Print is a standard for enhancing the communication between digital cameras and printers. By connecting to an Exif Print-compliant printer, the camera's image data at the time of shooting is used and optimized, yielding extremely high quality prints.

Battery Performance (Battery Pack NB-2LH at full charge)

	Number of Images Shot		Playback Time
	LCD Monitor on	LCD Monitor off	
PowerShot S60	Approx. 240	Approx. 550	Approx. 3 hours 30 min.

- * The data above reflects standard Canon testing conditions. The actual figures will vary according to the shooting conditions and settings.
- * Movie data is excluded.
- * At low temperatures, the battery pack performance may diminish and the low battery icon appear very rapidly.
In these circumstances, the performance can be improved by warming the battery pack in a pocket before use.

Test Conditions

Shooting: Normal temperature (23 °C/73 °F), alternating wide angle and telephoto end shots at 20-second intervals with flash fired once every four shots and camera power turned off and on every eighth shot. CF card used. LCD monitor brightness set to factory default.
















Playback: Normal temperature (23 °C/73 °F), continuous playback at one image per 3 seconds. CF card used. LCD monitor brightness set to factory default.



See *Battery Pack Handling Precautions* (p. 17).

CF Cards and Estimated Capacities (Recordable Images)

 With card included with the camera

			FC-32MH	FC-64M	FC-128M	FC-256MH	FC-512MSH
L (Large)	2592 x 1944 pixels		11	24	49	99	198
			21	43	88	177	354
			43	88	176	355	709
M1 (Medium 1)	2048 x 1536 pixels		18	38	76	154	308
			33	68	137	276	552
			67	136	274	548	1095
M2 (Medium 2)	1600 x 1200 pixels		30	61	122	246	491
			54	109	219	440	879
			108	217	435	868	1734
S (Small)	640 x 480 pixels		120	241	482	962	1891
			196	393	788	1563	3122
			337	676	1355	2720	5203
RAW	2592 x 1944 pixels		5	12	25	51	102
Movie*	640 x 480 pixels		46 sec.	92 sec.	186 sec.	374 sec.	742 sec.
	320 x 240 pixels		91 sec.	183 sec.	368 sec.	735 sec.	1451 sec.
	160 x 120 pixels		242 sec.	486 sec.	973 sec.	1954 sec.	3902 sec.
















- These figures reflect standard shooting conditions established by Canon. Actual totals may vary according to the subject, shooting conditions and shooting mode.
- The following are the maximum length of individual movie clips:
: 30 seconds, : 3 minutes, : 3 minutes. The maximums in the chart reflect continuous shooting.
- L (Large), M1 (Medium 1), M2 (Medium 2), S (Small) and , ,  indicate the resolution.
-  (Superfine),  (Fine) and  (Normal) indicate the relative compression ratio.
- Some CF cards are not sold in some regions.

Image File Sizes (Estimated)

Resolution		Compression		
				
L	2592 x 1944 pixels	2503 KB	1395 KB	695 KB
M1	2048 x 1536 pixels	1602 KB	893 KB	445 KB
M2	1600 x 1200 pixels	1002 KB	558 KB	278 KB
S	640 x 480 pixels	249 KB	150 KB	84 KB
RAW	2592 x 1944 pixels	4725 KB		
	 640 x 480 pixels	660 KB/sec.		
Movie	 320 x 240 pixels	330 KB/sec.		
	 160 x 120 pixels	120 KB/sec.		

Wireless Controller WL-DC100 (Sold Separately)

Power supply	: Date battery CR2025
Operating temperatures	: 0 – 40 °C (32 – 104 °F)
Dimensions	: 35 x 6.5 x 56.6 mm (1.4 x 0.3 x 2.2 in.)
Weight	: Approx. 10 g (0.4 oz.)

CompactFlash™ Card

Card slot type	: Type I
Dimensions	: 36.4 x 42.8 x 3.3 mm (1.4 x 1.7 x 0.1 in.)
Weight	: Approx. 10 g (0.4 oz.)

Battery Pack NB-2LH

Type	: Rechargeable lithium ion battery
Nominal voltage	: DC 7.4 V
Nominal amperage	: 720 mAh
Charge cycles	: Approx. 300
Operating temperatures	: 0 – 40 °C (32 – 104 °F)
Dimensions	: 33.3 x 45.2 x 16.2 mm (1.3 x 1.8 x 0.6 in.)
Weight	: Approx. 43 g (1.5 oz.)

Battery Charger CB-2LT / CB-2LTE

Input voltage	: AC 100 – 240 V (50/60 Hz) 0.17 A (100V) – 0.10 A (240V)
Rated output	: 8.4 V DC, 0.5 A
Charging time	: Approx. 90 minutes
Operating temperatures	: 0 – 40 °C (32 – 104 °F)
Dimensions	: 91 x 29.5 x 56 mm (3.6 x 1.2 x 2.2 in.)
Weight	: CB-2LT: Approx. 86 g (3.0 oz.) : CB-2LTE: Approx. 82 g (2.9 oz.)

Compact Power Adapter CA-PS700

(Included with the AC Adapter Kit ACK700)

Input voltage	: AC 100 – 240 V (50/60 Hz) 0.32 A
Rated output	: DC 7.4 V/2.0 A
Operating Temperatures	: 0 – 40 °C (32 – 104 °F)
Dimensions	: 112 x 29 x 45 mm (4.4 x 1.1 x 1.8 in.) (body only)
Weight	: Approx. 186 g (6.6 oz.)

Car Battery Charger CBC-NB2 (sold separately)

Rated Input	: DC 12 V / 24 V
Rated Output	: DC 8.4 V / 0.55 A
Operating temperatures	: 0 – 40 °C (32 – 104 °F)
Dimensions	: 91 x 56 x 29.5 mm (3.6 x 2.2 x 1.2 in.)
Weight	: Approx. 145 g (5.1 oz.)

Tele-converter TC-DC10 (Sold Separately)

Magnification	: Approx. 2.0
Focal range	: 200 mm (35mm film equivalent)
Lens composition	: 4 elements in 3 groups
Shooting distance (from the front of the lens)	: 1.2 m – infinity (3.9 ft. – infinity)
Thread diameter	: 37 mm standard filter thread Conversion Lens Adapter LA-DC10 is required to attach this lens to the PowerShot S60
Dimensions	: Diameter: 63.5 mm (2.5 in.) : Length: 54.5 mm (2.1 in.)
Weight	: Approx. 145 g (5.1 oz.)

Conversion Lens Adapter LA-DC10

Thread Diameter	: 37 mm standard filter thread
Dimensions	: Attached: 61.7 x 69.6 x 74.8 mm (2.4 x 2.7 x 2.9 in.) : Stored: 61.7 x 76.3 x 41.8 mm (2.4 x 3.0 x 1.6 in.)
Weight	: Approx. 30 g (1.1 oz.)

Photo Tips and Information

Regarding the AF Frame (p. 76)

AiAF* has a wide range of measuring for accurate focusing. AiAF focuses on the object even if it is not exactly in the center of the frame.

* "Ai" stands for "Artificial intelligence" and "AF" stands for "Auto Focus."

ISO Speed (p. 84)

The ISO speed is the numeric representation of the camera's sensitivity to light. The higher the ISO speed, the higher the sensitivity. A high ISO speed allows you to shoot images in dark indoor or outdoor conditions without a flash and also helps prevent blurred images due to camera shake. This is convenient when shooting images in places where flash photography is prohibited. The ISO speed setting makes full use of the available light, resulting in images that convey the feel of the place they were shot.



ISO 50 equivalent



ISO 400 equivalent.

RAW format (p. 57)

With the standard JPEG file format, the camera processes images after capturing them to produce optimal results. The JPEG format compresses images so that more can be stored on a single CF card. However, the compression is irreversible, meaning that the original image data cannot be recovered after processing. In contrast, the RAW format records the image data as captured by the camera's CCD without further processing. RAW images are compressed, but the compression is reversible** so that a high-quality image can be obtained from the decompressed file without any loss of image quality. In addition, although a RAW file is larger than an equivalent JPEG file, it is still only approximately one-quarter the size* of an uncompressed RGB TIFF format file, making it relatively compact.

With standard uncompressed file formats, such as RGB TIFF, images are processed in the camera and require further processing by retouching software to adjust the image parameters, which reduces image quality. With the RAW format, however, the original data can be used in special software** to adjust the image parameters (white balance, contrast, sharpness and saturation) making it possible to


maintain the image quality while making changes.

* As measured by Canon's testing standard.

** The bundled software can be used to open or adjust the parameters of images recorded in the RAW file format. Please consult the Software Starter Guide for details.

Tip for Using the Self-timer (p. 53)

Normally, the camera shakes a little when you press the shutter button.

Setting the self-timer to  delays the shutter release for two seconds and allows the camera to stop shaking, thus preventing a blurred image.

Even better results can be obtained by placing the camera on a stable surface or by using a tripod to shoot.

Histogram Function (p. 27)

The histogram is a graph that allows you to judge the brightness of the shot image. The greater the bias toward the left in the graph, the darker the image. The greater the bias toward the right, the brighter the image. If the image is too dark, adjust the exposure compensation to a positive value. Similarly, adjust the exposure compensation to a negative value if the

image is too bright (p. 80).



Dark Image



Balanced Image

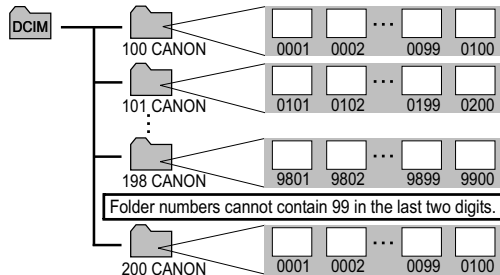


Bright Image

Managing Image Files (p. 112)

About File and Folder Numbers

Images are assigned file numbers from 0001 to 9900, and folders are assigned folder numbers from 100 to 998 (Folder numbers cannot contain 99 in the last two digits).



Folder File Capacity

Each folder usually contains up to 100 images. However, since images shot in Continuous mode and Stitch Assist mode are always saved into the same folder, a folder may contain more than 100 images. The number of images may also exceed 100 if a folder contains images copied from a computer or images shot with other cameras.

Please note, however, that the images in folders containing 2001 or more images cannot be played back in this camera.

How to Adjust the Exposure (p. 80)

This camera automatically adjusts the exposure to shoot images with the optimal brightness. However, recorded images may sometimes be brighter or darker than the actual image depending on the shooting conditions. If this happens, adjust the exposure compensation manually (p. 80).

Underexposure

The whole recorded image is dark, which makes white elements of the image appear gray. Shooting bright subjects or in backlit conditions may cause



the image to be underexposed. Adjust the exposure compensation towards the + end.

Optimal Exposure



Overexposure

The whole recorded image is bright, which makes black elements of the image appear gray. Shooting dark subjects or in dark places may cause the image to be overexposed. Adjust the exposure compensation towards the - end.





Index

Numerics

- 1st-curtain 93
- 2nd-curtain 93

A



- Adjusting the Exposure 80
- AE Lock 89
- AEB Mode 86
- AF-assist Beam 32
- AF Frame () 27, 76
- AF Lock Mode 97
- Aperture value 72
- Auto () 30
- Auto Power Down 69, 109
- Auto Rotate Function 69, 111
- Automated Playback (Slide Show) 104

B

- B/W 85
- Battery
 - Charge Battery 14
 - Handling 17
 - Status 18

C

- CF Card
 - Formatting 19

- Handling 18
- Color Effect () 85
- Compression 35
- Continuous Shooting () 56
- Contrast color 85
- Creative Zone 72

D

- Date/Time 24, 69
- Detailed Display 27
- Digital Zoom 54, 67
- DISPLAY 12, 27
- Display Off 69, 109
- Distance Units 69
- DPOF


- Print Order 68, 128
- Transfer Order 68, 133

- Drive Mode 56





E




- Erase all 68
- Erasing
 - Erasing All Images 47
 - Erasing Images Individually 46


F




- Fast Shutter () 48


FE Lock	90
File No. Reset	69
File Numbers	112
Flash	10, 38, 66
Adjustment Settings	91
Sync	66
Timing at which the Flash Fires	93
Focus	31, 96
Focus Lock	96
Focus-BKT Mode	87
Format	69, 116
Formatting	19
Frame rate	58
FUNC.	63
Function	12
H	
Histogram Function	27, 160
I	
Image Zone	48
Index Playback	44
Indicator	13
Information View	27
Intervalometer	67, 94
ISO Speed	84

J	
JUMP	12, 45
L	
Landscape ()	48
Language	26, 69
LCD Brightness	69
LCD Monitor	12, 27
Light Metering Modes ()	66, 78
M	
Magnifying Images ()	43
Manual Exposure (M)	75
Manual Focus Mode	98
Menu	12, 64
My Camera Menu	70
Play Menu	67
Rec. Menu	66
Selecting Menus and Settings	63
Set up Menu	68
MF	12
MF-Point Zoom	67
Microphone ()	10, 103
Mode Dial	13, 48, 72
Movie	
Editing	60

Recording ()	58
Viewing	60
Mute	68
My Camera Settings	113
N	
Night Scene ()	48
O	
Omni Selector	12
Operation Sound	70, 113, 114
Operation Vol.	68
Overexposure Warning	29
P	
Playback	42, 102
Playback Mode	22
Playback Vol.	69
Portrait ()	48
Power On/Off	21, 22
Power Saving Function	69, 109
Power/Mode Indicator	13
Print Order	128
Print/Share button	121
Printing	126
Protect	108

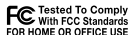
R	
RAW	57, 159
Red-Eye Reduction ()	10, 38, 39, 66
Remote Sensor	10
Resetting the File Numbers	112
Resetting the Settings to Default	71
Resolution	35
Review	67
Rotate	67
Rotating Images	102
S	
Safety Shift	75
Saturation	86
Save Settings (C)	67
Saving Custom Settings	100
Self-timer	53
Selftimer Sound	68, 113, 114
Selftimer Vol.	68
Sharpness	86
Shooting	
Movie	58
Shooting Mode	21, 22
Shutter	
Button	12

Pressing	31
Sound	31, 68, 113, 114
Speed	72
Volume	68
Slide Show	68, 104
Play Time	107
Repeat	107
Selecting Images	105
Starting	105
Slow Shutter ()	48
Slow Synchro	39, 66
Sound Memos	103
Speaker	12
Standard Display	27
Start-up Image	21, 70, 113, 114
Start-up Sound	21, 70, 113, 114
Start-up Vol.	68
Stitch Assist ()	48, 50
T	
Tele-converter	145
Telephoto ()	12, 30
Terminal Cover	12
Transfer Order	133

Transmission settings	
Image Transmission settings	133
V	
Video System	69
Viewfinder	12, 32
Viewing	
Images on a TV Set	124
Volume	68
W	
White Balance (WB)	81
Wide Angle ()	12, 30
Wireless Controller	143
Wireless Delay	66
Z	
Zoom	12, 30, 43, 54

FCC Notice

(Digital Camera, Model PC1088)



This device complies with Part 15 of the FCC Rules. Operation is subject to the following two conditions;

- (1) this device may not cause harmful interference, and
- (2) this device must accept any interference received, including interference that may cause undesired operation.

Note: This equipment has been tested and found to comply with the limits for Class B digital devices, pursuant to Part 15 of the FCC rules. These limits are designed to provide reasonable protection against harmful interference in a residential installation. This equipment generates, uses and can radiate radio frequency energy and, if not installed and used in accordance with the instructions, may cause harmful interference to radio communications. However, there is no guarantee that interference will not occur in a particular installation. If this equipment does cause harmful interference to radio or television reception, which can be determined by turning the equipment off and on, the user is encouraged to try to correct the interference by one or more of the following measures:

- Reorient or relocate the receiving antenna.
- Increase the separation between the equipment and receiver.
- Connect the equipment into an outlet on a circuit different from that to which the receiver is connected.
- Consult the dealer or an experienced radio/TV technician for help.

The cables with the ferrite core provided with the digital camera must be used with this equipment in order to comply with Class B limits in Subject B of Part 15 on the FCC rules.

Do not make any changes or modifications to the equipment unless otherwise specified in the manual. If such changes or modifications should be made, you could be required to stop operation of the equipment.

Canon U.S.A. Inc.

One Canon Plaza, Lake Success, NY 11042, U.S.A.
Tel No. (516) 328-5600

Canadian Radio Interference Regulations

This Class B digital apparatus complies with Canadian ICES-003.

Réglementation canadienne sur les interférences radio

Cet appareil numérique de la classe B est conforme à la norme NMB-003 du Canada.

MEMO

MEMO

MEMO

Functions Available in Each Shooting Mode

This chart shows the functions available in each shooting mode. You can shoot with the settings saved in the **C** mode (p. 100).

														Ref. Page
Resolution (Stills)	Large	L	○*	○*	○*	○*	○*	○*	△*	-	○*	○*	○*	p. 35
	Medium 1	M1	○	○	○	○	○	○	△	-	○	○	○	
	Medium 2	M2	○	○	○	○	○	○	△	-	○	○	○	
	Small	S	○	○	○	○	○	○	△	-	○	○	○	
Resolution (Movies)	640 x 480 pixels		-	-	-	-	-	-	-	○	-	-	-	p. 35
	320 x 240 pixels		-	-	-	-	-	-	-	○*	-	-	-	
	160 x 120 pixels		-	-	-	-	-	-	-	○	-	-	-	
Compression	Superfine		○	○	○	○	○	○	△	-	○	○	○	p. 35
	Fine		○*	○*	○*	○*	○*	○*	△*	-	○*	○*	○*	
	Normal		○	○	○	○	○	○	△	-	○	○	○	
File Format	JPEG		○	○	○	○	○	○	○	-	○*	○*	○*	p. 57
	RAW		-	-	-	-	-	-	-	-	○	○	○	
Flash	Auto		○*	○*	○	○*	○*	○	-	-	○	-	-	p. 38
	On		-	○	○	○	○	○	△	-	○	○	○	
	Off		○	○	○*	○	○	○*	△*	-	○*	○*	○*	
Red-eye Reduction			○	○	○	○	○	○	△	-	○	○	○	p. 38
Slow Synchro	On		-	-	○	○	-	○	△	-	○	-	○	p. 39
	Off		○	○	-	-	○	-	△*	-	○*	○	○	

										P	Tv	Av	M	Ref. Page	
Flash Adjust	On	○	○	○	○	○	○	○	○	-	○	○*	○*	-	p. 91
	Off	-	-	-	-	-	-	-	-	-	-	○	○	○	
Flash Sync	1st-curtain	○	○	○	○	○	-	○	-	○*	○*	○*	○*	p. 93	
	2nd-curtain	-	-	-	-	-	○	-	-	○	○	○	○		
AF-assist Beam		○	○	○	○	○	○	△	○	○	○	○	○	p. 32	
Drive Mode	Single Shot	○*	○*	○*	○*	○*	○*	○*	○*	○*	○*	○*	○*	-	
	Standard Continuous Mode	-	○	○	○	○	○	-	-	○	○	○	○	p. 56	
	High Speed Continuous mode	-	○	○	○	○	○	-	-	○	○	○	○		
	Self-Timer (10 sec.)	○	○	○	○	○	○	△	○	○	○	○	○	p. 53	
	Self-Timer (2 sec.)	○	○	○	○	○	○	△	○	○	○	○	○		
	Remote Control	○	○	○	○	○	○	△	○	○	○	○	○		
Intervalometer		-	-	-	-	-	-	-	-	○	○	○	○	p. 94	
AF Frame	Auto	○*	○*	○*	○*	○*	○*	○	○	-	-	-	-	p. 76	
	Center Point	○	○	○	○	○	○	-	-	○*	○*	○*	○*		
	Manual	-	-	-	-	-	-	-	-	○	○	○	○		
AF Lock		-	○	○	○	○	○	○	○	○	○	○	○	p. 97	
Manual Focus		-	○	○	○	○	○	○	○	○	○	○	○	p. 98	

										P	Tv	Av	M	Ref. Page
Macro Mode		○	○	–	○	○	○	○	○	○	○	○	○	p. 52
Digital Zoom	On	○	○	○	○	○	○	–	–	○	○	○	○	p. 54
	Off	○*	○*	○*	○*	○*	○*	–	–	○*	○*	○*	○*	
Exposure Compensation		–	○	○	○	○	○	△	○	○	○	○	–	p. 80
Light Metering System	Evaluative Metering		○	○	○	○	○	○	○	○*	○*	○*	○*	p. 78
	Center-Weighted Averaging		–	–	–	–	–	–	–	○	○	○	○	
	Spot Metering		–	–	–	–	–	–	–	○	○	○	○	
	Center		–	–	–	–	–	–	–	○*	○*	○*	○*	
	AF Point		–	–	–	–	–	–	–	○	○	○	○	
AE Lock/FE Lock		–	–	–	–	–	–	–	–	○	○	○	–	p. 89, 90
Bracket	AEB		–	–	–	–	–	–	–	○ ⁽¹⁾	○ ⁽¹⁾	○ ⁽¹⁾	–	p. 86
	Focus-BKT		–	–	–	–	–	–	–	○ ⁽²⁾	○ ⁽²⁾	○ ⁽²⁾	○ ⁽²⁾	p. 87
White Balance ⁽³⁾	WB	– ⁽⁴⁾	○	○	○	○	○	△	○ ⁽⁵⁾	○	○	○	○	p. 81
Photo Effect		–	○	○	○	○	○	△	○	○	○	○	○	p. 85
	Contrast/Sharpness/ Saturation		–	–	–	–	–	–	–	○	○	○	○	
Safety Shift	On	–	–	–	–	–	–	–	–	–	○	○	–	p. 75
	Off	○	○	○	○	○	○	○	○	○	○*	○*	○	
ISO Speed	ISO	– ⁽⁶⁾	– ⁽⁶⁾	– ⁽⁶⁾	– ⁽⁶⁾	– ⁽⁶⁾	– ⁽⁶⁾	– ⁽⁶⁾	– ⁽⁶⁾	○	○	○	○ ⁽⁷⁾	p. 84

										P	Tv	Av	M	Ref. Page
Auto Rotate	On	○*	○*	○*	○*	○*	○*	△*	—	○*	○*	○*	○*	p. 111
	Off	○	○	○	○	○	○	△	○	○	○	○	○	
JPEG Recording in RAW		—	—	—	—	—	—	—	—	○	○	○	○	p. 67

* Default setting ○: Setting selection is possible. △: Setting can only be selected for the first image.
 —: Setting selection is not possible.

- : Setting remains in effect even when the camera is turned off.
- The default for the settings changed by the menu and button operations can be restored all at once except for [Date/Time], [Language] and [Video System] (p. 71).

- (1) When the flash fires, AEB shooting cannot be carried out.
- (2) Selectable only in manual focus.
- (3) Cannot be adjusted when the photo effect is set to [Sepia] or [B/W].
- (4) The white balance is set to [AUTO].
- (5) The white balance [Flash] cannot be set.
- (6) The ISO speed is automatically set by the camera.
- (7) ISO [AUTO] cannot be selected.